

TOP DEAL

OUR BESTSELLER



KS TOOLS

WWW.KSTOOLS.COM – INNOVATION IS OUR MISSION!

Safety first

EXTREMELY HIGH LOAD
MAX. LOAD OF
2600 KG
EXTREMELY HIGH LOAD



▶ INCLUDED

▶ WITH SAFETY NOSE

500.8400

Universal coil spring compressor set, 6 pcs



Ø 80 - 160 MM

Ø 140 - 195 MM



only **399,00€**

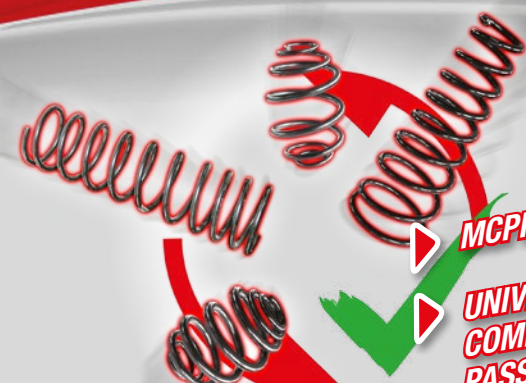

MCPHERSON SPRING FEET
UNIVERSAL FOR 90% OF
COMMON VEHICLE SPRINGS IN
PASSENGER CARS AND TRANSPORTERS

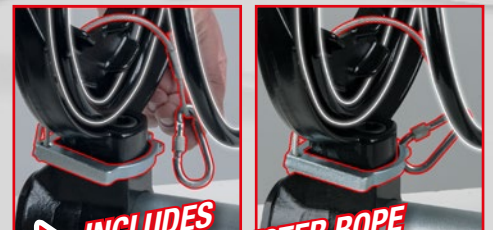

▶ INCLUDES SAFETY ARRESTER ROPE

897.7215

ECOline BLACK/RED TOOLBOX WITH SEVEN DRAWERS AND 215 PREMIUM TOOLS

- Ideal set for universal use
- With self-closing mechanism and SOFT-CLOSE function
- Robust and stable steel construction with 0,8 mm sheet steel - distortion resistant
- Side walls with metal peg board for mounting different accessories
- Central locking system on all drawers through the cylinder lock

ECO *Line*



215
pcs

max.
300 kg

max.
25 kg

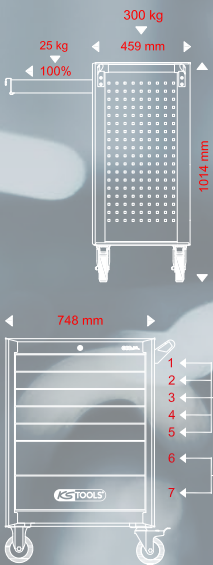

**The
cho
guaran**



713.0215

SET OF UNIVERSAL SYSTEM INSERTS FOR 3 DRAWERS WITH 215 PREMIUM TOOLS

1 711.0013

⊖ 3/4/5/5/6,5/8mm ⊕ PH1/PH2/PH3

2 711.0027

6/7/8/9/10/11/12/
13/14/15/16/17/18/
19/21/22 mm 6x7/8x9/10x11/
12x13/14x15/16x17/
18x19/20x22 mm

3 711.0179

1/4" 3/8" 1/2"

⊖ 4 - 12 mm ⊖ 4 - 32 mm
 ⊕ PH0 - PH4 ⊕ E4 - E24
 ⊕ PZ0 - PZ4 ⊕ 1,3 - 14 mm
 ⊕ T5 - T70 ⊕ TS10 - TS40
 ⊕ TB5 - TB70 ⊕ M5 - M8
 ⊕ M5 - M9

ECO *Line*
+ 215 parts!

499,00 €

*All prices are ex. VAT.

STANDARD

SPECIAL

826.7215

RACINGline BLACK/RED TOOLBOX WITH SEVEN DRAWERS AND 215 PREMIUM TOOLS

- Very stable steel construction with 0,9 mm sheet steel - distortion resistant
- High level of stability
- Side walls with metal peg board for mounting different accessories
- Handle locking system prevents unintentional opening
- Central locking system on all drawers through the cylinder lock

RACING *Line*



215
pcs



**right
price
guaranteed!**

713.0215

SET OF UNIVERSAL SYSTEM INSERTS FOR 3 DRAWERS WITH 215 PREMIUM TOOLS

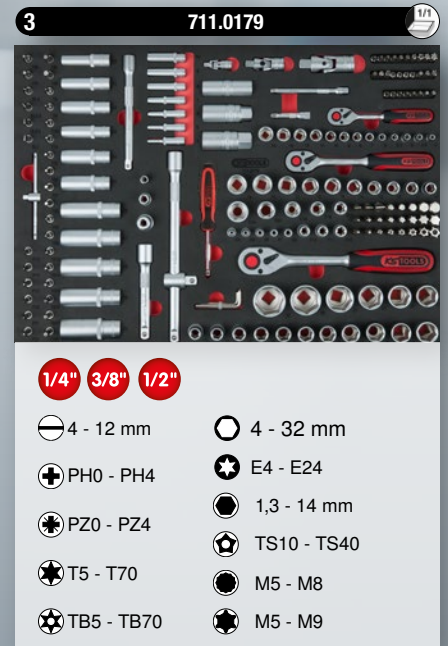
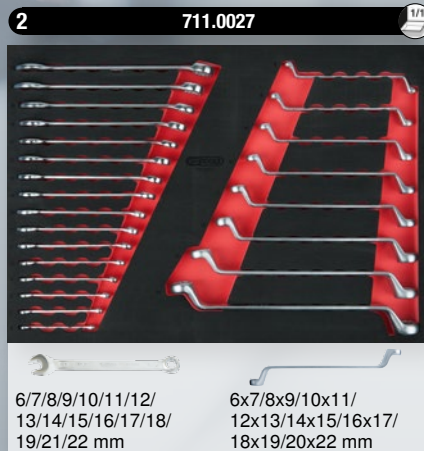
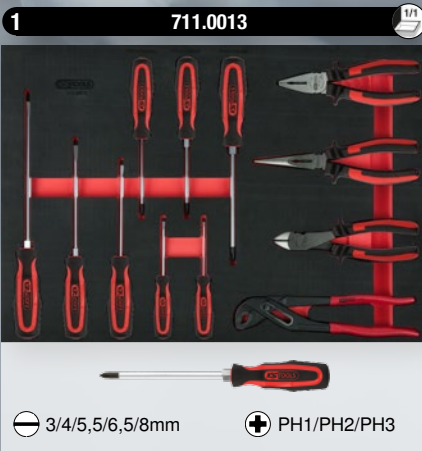

RACING *Line*

+ 215 parts!

549,00 €

*All prices are ex. VAT.

826.7515

RACINGline BLACK/RED TOOLBOX WITH SEVEN DRAWERS AND 515 PREMIUM TOOLS

- Ideal set for universal use
- Very stable steel construction with 0,9 mm sheet steel - distortion resistant
- High level of stability
- Side walls with metal peg board for mounting different accessories
- Central locking system on all drawers through the cylinder lock

RACING *Line*

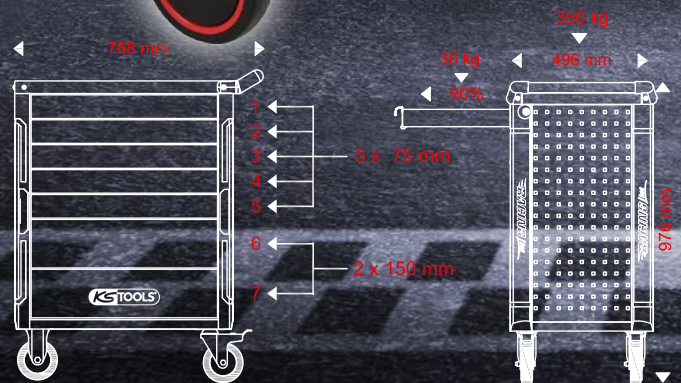

MORE THAN 500 TOOLS FOR 4 DRAWERS

STANDARD

12V SPECIAL

*All prices are ex. VAT.



515 pcs

713.0515

SET OF UNIVERSAL SYSTEM INSERTS FOR 4 DRAWERS WITH 515 PREMIUM TOOLS

1 711.1018



2 711.3035

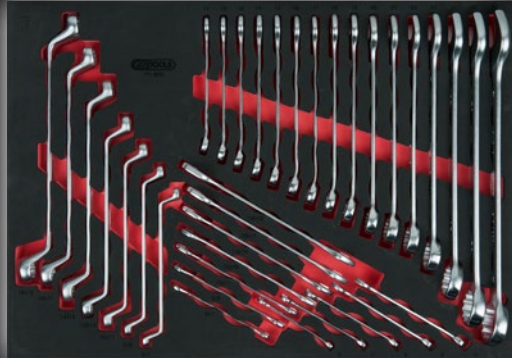

6/7/8/9/10/11/12/13/14/15/16/17/18/19/21/22/24/27/30/32 mm 6x7/8x9/10x11/12x13/14x15/16x17/18x19 mm

3 711.1059



3 - 10 mm PH0 - PH3 PZ0 - PZ3

4 711.0195

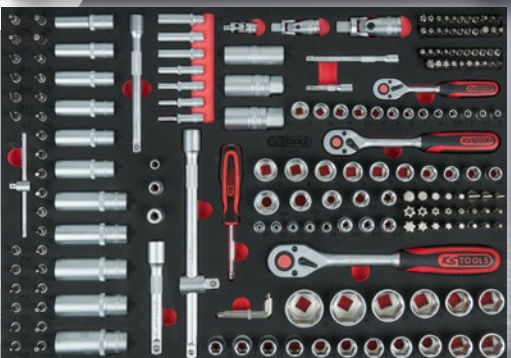

515 parts!



- 1/4": 4/4,5/5/5,5/6/7/8/9/10/11/12/13/14 mm 1/4": E4/E5/E6/E7/E8
- 3/8": 10/11/12/13/14/15/16/17/18/19 mm 3/8": E10/E11/E12/E14/E16/E18
- 1/2": 10-11-12-13-14-15-16-17-18-19-20-21-22-24-27-30-32 mm 1/2": E20/E24
- 1,3 - 1,5/2/2,5/3/4/5/6/7/8/10/12 mm
- T5/T6/T7/T8/T9/T10/T15/T20/T25/T27/T30/T40/T45/T50/T55/T60
- TB7/TB8/TB9/TB10/TB15/TB20/TB25/TB27/TB30/TB40/TB45/TB50/TB55/TB60
- 4/5,5/6,5/7/8/10/12 mm M5/M6/M8
- PH0/PH1/PH2/PH3/PH4 M5/M6/M7/M8/M9
- PZ0/PZ1/PZ2/PZ3/PZ4
- TS10/TS15/TS20/TS25/TS27/TS30/TS40/TS45

749,00 €

*All prices are ex. VAT.



598 pcs

RACING Line



max. 350 kg

max. 30 kg

0
OR
WERS

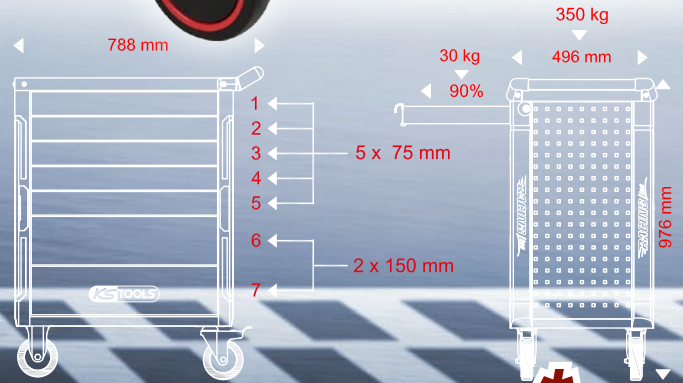

999,00 €



*All prices are ex. VAT.

ERGOTORQUE® precision TORQUE WRENCH WITH ROTARY MUSHROOM RATCHET HEAD

- Actuation accuracy: $\pm 3\%$ tolerance of the set scale value
- Precise reading accuracy for a minimum 5.000 tightening cycles
- For controlled fastening in clockwise and counter clockwise directions
- An audible and palpable signal when the desired torque value is achieved
- Torque setting is quick and easy using the locking knob in the handle end

Item no	Torque:		
516.1402	1/4"	1-5 Nm	€ 79,00
516.1412	1/4"	5-25 Nm	€ 79,00
516.1422	3/8"	10-50 Nm	€ 79,00
516.1432	1/2"	20-100 Nm	€ 89,00
516.1442	1/2"	40-200 Nm	€ 89,00
516.1472	1/2"	60-320 Nm	€ 99,00
516.1482	1/2"	80-420 Nm	€ 109,00
516.1490	3/4"	110-550 Nm	€ 449,00
516.1493	3/4"	150-750 Nm	€ 479,00
516.1495	1"	200-1000 Nm	€ 549,00



Certified precision

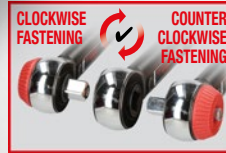

with micrometer scale

MUSHROOM HEAD WITH SQUARE

Change the direction of rotation by simply rotating the square drive

from **79,00** €

SOCKET SET

THE COMFORTABLE ONE

- 4 - 4,5 - 5 - 5,5 - 6 - 7 - 8 - 9 - 10 - 11 - 12 - 13 - 14 - 15 - 16 - 17 - 18 - 19 - 20 - 21 - 22 - 24 - 27 - 30 - 32 mm



195 pcs

1/4" 3/8" 1/2"

Matt finish

Mirror polished

917.0795 **89,00** €

918.0795 **89,00** €

SOCKET SET

THE COMPLETE ONE

- 4 - 4,5 - 5 - 5,5 - 6 - 7 - 8 - 9 - 10 - 11 - 12 - 13 - 14 - 15 - 16 - 17 - 18 - 19 - 20 - 21 - 22 - 24 - 27 - 30 - 32 mm



216 pcs

1/4" 3/8" 1/2"

Matt finish

Mirror polished

917.0216 **139,00** €

918.0216 **139,00** €

UNIVERSAL TOOL KIT SET

THE CLEVER ONE

- 4 - 4,5 - 5 - 5,5 - 6 - 7 - 8 - 9 - 10 - 11 - 12 - 13 - 14 - 15 - 16 - 17 - 19 - 20 - 21 - 22 - 24 - 27 - 30 - 32 mm



97 pcs

1/4" 1/2"

Matt finish

Mirror polished

917.0797 **139,00** €

918.0797 **139,00** €

911.0721

SOCKET SET

THE ROBUST ONE

- 19 - 21 - 22 - 23 - 24 - 26 - 27 - 29 - 30 - 32 - 35 - 36 - 38 - 41 - 46 - 50 mm



21 pcs

3/4"

179,00 €

*All prices are ex. VAT.

911.0727

UNIVERSAL TOOL KIT



127 pcs

THE ALL-ROUNDER

- 4 - 4.5 - 5 - 5.5 - 6 -
- 7 - 8 - 9 - 10 - 11 -
- 12 - 13 - 14 - 16 -
- 17 - 18 - 19 - 20 -
- 22 - 24 - 27 - 30 -
- 32 mm

1/4"

1/2"

299,00 * €

940.0047

UNIVERSAL TOOL KIT SET



THE SOLID ALL ROUNDER

47 pcs



- 10 - 11 - 12 - 13 - 14 -
- 15 - 16 - 17 - 18 - 19 -
- 20 - 21 - 22 - 24 mm

1/2"

129,00 * €

MODIFIX® MINI T-HANDLE RATCHET, ROTATING HEAD



- Reversible
- Fine gearing 72 teeth ratchet mechanism
- Multifunctional use
- Rotating shaft adjustable for constant tightening in the base of the rotating head

Application: T-handle ratchet / screwdriver ratchet Adjustable in 2 positions 0° + 90°

MODIFIX



Item no	Square drive:	Price
914.1405	1/4"	€ 35,00
914.3815	3/8"	€ 39,00

1/4" 3/8"

from **35,00** * €

920.0002

SLIMPOWER REVERSIBLE RATCHET SET



- According to DIN 3122 / ISO 3315
- Square drive adaptor to DIN 3120 / ISO 1174 with ball lock
- Reversible
- Extremely slim head
- Fine gearing 72 teeth ratchet mechanism

2 pcs



1/4" 1/2"

49,00 * €

911.0009

WOBBLE EXTENSION SET



- Internal square to DIN 3120 / ISO 1174 with ball reception
- Wobble extension with ball lock
- 8° tilt angle to each side
- For manual operation
- Matt finish

9 pcs

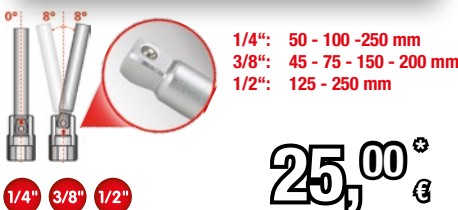

1/4" 3/8" 1/2"

25,00 * €

917.0707

ADAPTOR AND REDUCING ADAPTOR SET



ADAPTOR AND REDUCING ADAPTOR SET

7 pcs



1/4" 3/8" 1/2" 3/4"

15,00 * €

*All prices are ex. VAT.

515.0055

HEXAGON IMPACT SOCKET SET, EXTRA SHORT

- 6 point
- Very flat design
- According to DIN 3129 / ISO 2725-2
- Internal square drive to DIN 3121 / ISO 1174
- Short execution

10 - 11 - 12 - 13 - 14 - 15 - 16 - 17 - 18 - 19 - 20 - 21 - 22 - 23 - 24 mm



15 pcs

EXTRA-SHORT

28 mm



49,00* €

515.0100

IMPACT ADAPTOR AND REDUCING ADAPTOR SET

- Ideal set of compilation for adaptors and ball joints
- Chrome molybdenum
- In durable wheeled storage case



9 pcs

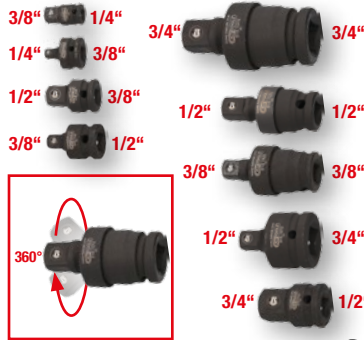

1/4" 3/8" 1/2" 3/4"

79,00* €

503.4565

4 IN 1 GEARplus® REVERSING DOUBLE RATCHET RING SPANNER

- FlankTraction profile
- Straight form
- Exact gearing with 72 teeth
- Four different sizes on each spanner
- With reversing lever



10 19
4/1
13 17

17,50* €

517.0052

COMBINATION SPANNERS SET, OFFSET

- FlankTraction profile
- Jaw 15° offset
- Ring head 15° offset
- Polished heads
- Matt finish



12 pcs



8 - 9 - 10 - 11 - 12 - 13 - 14 - 15 - 16 - 17 - 18 - 19 mm

29,00* €

517.0043

COMBINATION SPANNERS SET, OFFSET

- FlankTraction profile
- Jaw 15° offset
- Ring head 15° offset
- Polished heads
- Matt finish



21 pcs



6 - 7 - 8 - 9 - 10 - 11 - 12 - 13 - 14 - 15 - 16 - 17 - 18 - 19 - 20 - 21 - 22 - 24 - 27 - 30 - 32 mm

79,00* €

503.4250

GEARplus® COMBINATION RATCHETING SPANNER SET

- FlankTraction profile
- Jaw 15° offset
- Straight form
- Exact gearing with 72 teeth
- High quality finish



10 pcs



8-10-11-12-13-14-16-17-18-19 mm

99,00* €

503.4960

GEARplus® REVERSING COMBINATION RATCHETING SPANNER SET

- FlankTraction profile
- Jaw 15° offset
- Ratchet head offset at 15°
- With reversing lever
- Versatile sockets with go through function



30 pcs

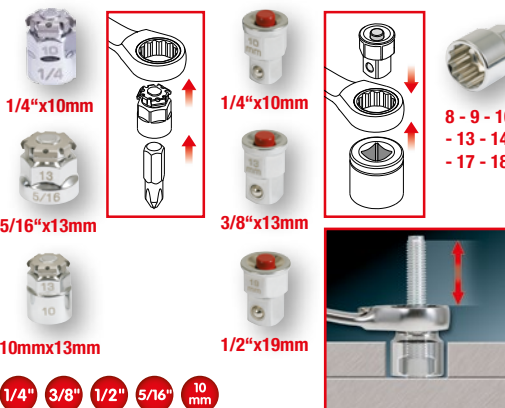

149,00* €

577.0352

ADJUSTABLE SPANNER WITH RATCHET

- DIN 3117 Form A
- Jaw 15° offset
- Swedish type design
- Integrated ratchet function
- left-handed roller



0 - 32 mm

250 mm

19,00* €

*All prices are ex. VAT.

918.1495

CHROMEplus® BIT REVERSING RATCHET

- For bits with external hexagon drive to DIN 3126 / ISO 1173 - C 6,3
- Reversible
- Exact gearing with 72 teeth
- Two component handle
- Mirror polished



1/4"

15,00* €



911.2060

BIT SET

- Can be used by hand or with an electric screwdriver
- Includes magnetic quick release bit holder and 1/4" socket adapter
- Ideally suited for fittings in trade and industry
- Precise and orderly arrangement of the popular 1/4" bits
- Special tool steel

1/4"

- ⊕ PH1 - PH2 - PH3
- ⊕ 2x PZ1 - 2x PZ2 - 2x PZ3
- ⊖ 5,5 - 6,5 - 8 mm
- 4 - 5 - 6 mm
- ⊗ 2x TB10 - 2x TB20 - 2x TB40 - 3x TB15 - 3x TB25 - 3x TB30



50 mm

9,50* €



514.1148

MAGNETIC QUICK-CHANGE BIT HOLDER, EXTRA LONG

- Quick change function and locking device
- Magnetic
- with freewheel sleeve
- For 1/4" Bits with external hexagon drive to DIN 3126 / ISO 1173 - C 6,3
- Can be used by hand, electric screwdriver and drills



1/4"

19,00* €



918.3005

TORSIONPower BIT SOCKET BOX

- Can be used by hand or with an electric screwdriver
- Colour-coded bits
- 180° revolving head
- The extension can also be used as a T-handle
- Fine gearing 72 teeth ratchet mechanism

THE ALL-ROUNDER WITH SOCKETS



- ⊖ 4 - 6 mm
- ⊕ PH1 - PH2 - PH3
- ⊕ PZ1 - PZ2 - PZ3
- 3 - 4 - 5 - 6 mm
- ⊗ T10 - T15 - T20 - T25 - T27 - T30 - T40

- 5 - 6 - 7 - 8 - 9 - 10 - 11 - 12 - 13 - 14 mm



33 pcs

1/4"

49,00* €



159.0010

ERGOTORQUEplus® SCREWDRIVER SET

- Two component handle
- Optimal power transmission
- Hardened blade
- Chrome finish with burnished tips
- Blade made of chrome vanadium

SLOTTED & CROSS

6 pcs



- ⊖ 3 - 4 - 5,5 - 6,5 mm
- ⊕ PH1 - PH2

15,00* €



159.2051

REVOLVER RATCHET BIT SCREWDRIVER

- Ratchet function
- Exact gearing with 72 teeth
- Handle with double function (standard and pistol handle)
- 40 Nm maximum torque
- Integrated bit magazine



- ⊖ 5,5 - 6,5 mm
- ⊕ PH1 - PH2
- ⊗ PZ1 - PZ2

1/4"

17,50* €



*All prices are ex. VAT.

ERGOTORQUEplus® SCREWDRIVER SET

- Two component handle
- Optimal power transmission
- Hardened blade
- Chrome finish with burnished tips
- Blade made of chrome vanadium



6 pcs

T10
T15
T20
T25
T30
T40



TB10
TB15
TB20
TB25
TB30
TB40



159.0030 **15,00*** € 159.0040 **15,00*** €

159.0100

ERGOTORQUEplus® SCREWDRIVER AND BIT SET

- Two component handle
- Optimal power transmission
- Includes the most current 1/4" bits, bit holder and screwdriver bits
- Hardened blade
- Chrome finish with burnished tips



39 pcs



- 3 - 4 - 5,5 - 6
- 6,5 - 8 - 10 mm
- PH0 - PH1
- PH2 - PH3
- PZ0 - PZ1
- PZ2 - PZ3
- 2 - 2,5 - 3 - 4
- 5 - 6 - 8 mm
- T10 - T15 - T20 - T25
- T27 - T30 - T40
- TB10 - TB15 - TB20 - TB25
- TB27 - TB30 - TB40

39,00* €

151.1150

ERGOTORQUE®max HAMMER CAP SCREWDRIVER SET

- Hexagon drive
- Includes T-handle ratchet
- Protective cap on the handle end
- Optimal power transmission
- Hardened blade



13 pcs

- 3,5 - 5,5 - 6 - 7 - 8 - 10 mm
- PH0 - PH1 - PH2 - PH3 - PH4



1/4"



59,00* €

151.4880

TORX L-KEY SET, LONG

- Long execution
- Continuous hardened
- Matt chrome
- Special tool steel
- In durable folding holder



10 pcs

T8 - T10 - T15 - T20 - T25 - T27 - T30 - T40 - T45 - T50



152 mm

12,50* €

151.5000

BALL END HEXAGON SOCKET WRENCH SET, LONG

- Long execution
- With ball head on the long end
- Ideal for difficult to access screws
- In durable folding holder
- Continuous hardened



10 pcs

1,5 - 2 - 2,5 - 3 - 4 - 5 - 6 - 7 - 8 - 10 mm



180 mm

12,50* €

115.1197

POWER LOCKING PLIERS

- Forged gripping jaws
- Prevents slipping even at high forces
- Size adjustment using the adjustment wheel
- For round and flat material



0 - 50 mm

220 mm

15,00* €

*All prices are ex. VAT.

151.8150

T-HANDLE BALL ENDED HEXAGON KEY WRENCH SET

- With ball head on the long end
- Ideal for difficult to access screws
- Continuous hardened
- Special tool steel
- In durable plastic storage case



9 pcs



2 - 2,5 - 3 - 4 - 5 -
6 - 8 - 10 - 12 mm

39,00* €

151.8160

T-HANDLE TORX TAMPERPROOF KEY WRENCH SET

- Tamperproof
- Two component handle
- Continuous hardened
- Special tool steel
- In durable plastic storage case



9 pcs



TB10 - TB15 - TB20 -
TB25 - TB27 - TB30 -
TB40 - TB45 - TB50

39,00* €

118.0015

MINI BOLT CUTTER, SELF-RELEASING

- Cutting performance up to 60-63 HRC
- Cutter head made of high quality special steel
- Induction-hardened precision cutting
- Phosphate finish
- Chrome molybdenum

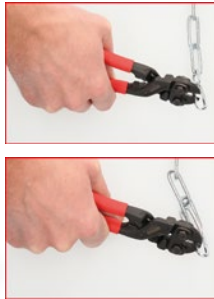

60-63 HRC

25,00* €

111.3550

PIPE WRENCH WITH ADJUSTABLE HEAD

- Type "Stillson"
- Aluminium cast body
- Stepless adjustment via milled nut
- 160° revolving handle
- Aluminium handle



39,00* €

150.9540

HAND RIVET TOOL

- Suitable for blind rivets
- 360° rotating head
- For difficult to access areas
- Narrow head pliers

Blind rivets: 2,4 - 3,2 - 4,0 - 4,8 mm



**BLIND RIVETS:
2,4 - 3,2 - 4,0 - 4,8 MM**

29,00* €

970.0150

BLIND RIVETS ASSORTMENT

- Breakable pin made from steel
- In plastic storage case



400 pcs



100 x 2,4 mm
100 x 3,2 mm
100 x 4,0 mm
100 x 4,8 mm

7,50* €

*All prices are ex. VAT.

115.1400

UNIVERSAL CRIMPING TOOL SET WITH AUTOMATIC WIRE STRIPPER

- Extremely robust and reliable crimping tool
- Inserts lock and to they click to prevent possible misuse
- Optimal crimping through precision profile
- Ratchet function
- Easy to change the crimp heads through quick locking device



283 pcs



- Crimp head for insulated terminals
- Crimp head for non-insulated terminals
- Crimp head for spade terminals 4,8 and 6,3 mm
- Crimp head for pin terminals
- Crimp head for coaxial terminals



159,00* €

960.1200

SMALL SOLDERING TORCH

- Gas operated micro soldering device up to 1,300°C / 2,450°F
- With piezo ignition
- Optimal for fine soldering
- Filled with standard lighter gas / ISO butan gas
- With table stand



960.1160

MICRO SOLDERING TERMINAL SET

- Gas operated micro soldering device up to 1,300°C / 2,450°F
- With piezo ignition
- Gas supply totally adjustable
- Filled with standard lighter gas / ISO butan gas
- Includes different attachments soldering wire and soldering sponge



11 pcs

WITH PIEZO IGNITION

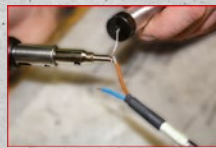
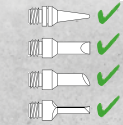

39,00* €

911.2175

PRECISION SCREWDRIVER SET

- Reversible interchangeable bits
- Twist end cap
- Clip for the breast pocket
- Plastic handle
- 4 mm special steel bits



4 pcs

4 IN 1

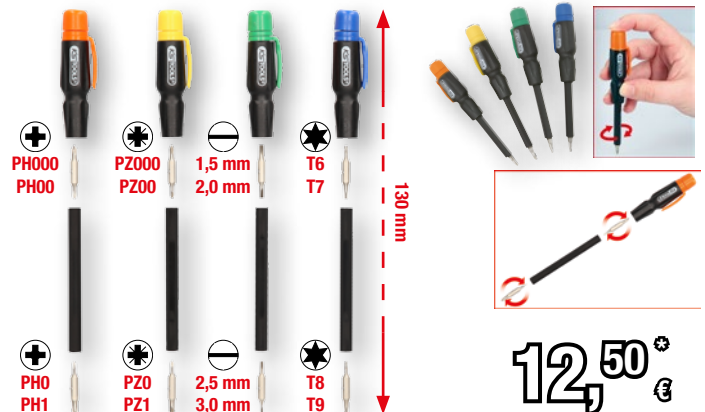

550.1080

MAGNET AND HOOK TOOL SET

- Ideal for removing and use of O rings and seals
- With telescopic magnet attachment and replaceable hook
- Storage compartment in the handle for the various attachments
- Special tool steel



6 pcs



300.0532

DIGITAL VERNIER CALLIPER 0 - 150 MM

- With fixed adjusting screw and fine rolling adjustment
- For external, internal, step and depth measurements
- mm/imperial switching
- Reset (to zero) in every position possible
- Stainless steel



*All prices are ex. VAT.

117.0610

VDE SCREWDRIVER SET WITH INTERCHANGEABLE BLADES

- Insulated to IEC 60900
- Automatic locking mechanism
- Blades held securely in handle
- Optimal power transmission
- Two component handle

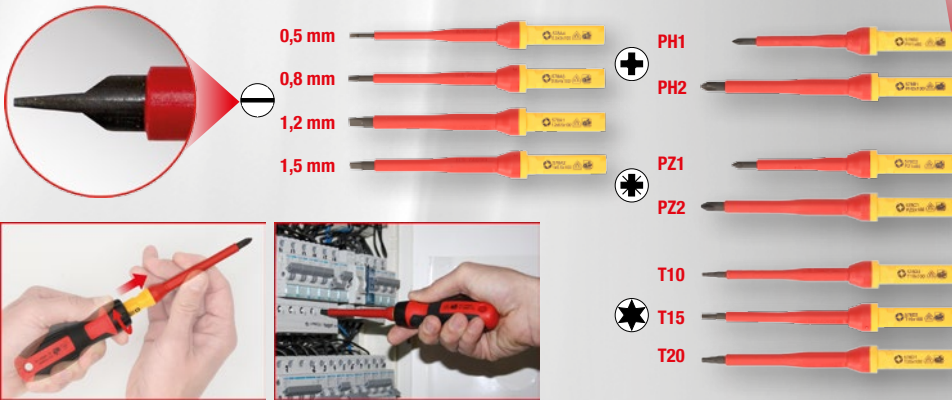

13 pcs

25,00* €

150.1495

DIGITAL MULTIMETER INCL. TEST PROBES

- Solid multimeter with basic measuring functions
- Test lead set with test tip (red/black)
- With base in protective rubber holster

Functions:

- DC and AC voltage measurement
- DC and AC current measurement
- Resistance measurement
- Diode test (with acoustic signal)
- Continuity test (with acoustic signal)
- Data hold function
- Battery check indicator



THE MULTITALENT



TECHNICAL DATA:

Fuse protection S1 (fine flow):	250mA/600V; 10A/600V
Working temperature:	0° to +40° C (32° to 104° F)
Co-current flow:	20 µA - 10 A
AC voltage:	200 V - 600 V
Resistance measurement:	200 Ohm - 2 MOhm

19,00* €

500.7195

ELECTRIC RECHARGEABLE PRECISION SCREWDRIVER

- Ideal for very long network independent working
- Lightweight
- With practical clockwise and anticlockwise reversing function
- High performance lithium-ion battery
- Fast charging function (0.5 - 1 hour)



INCLUDES 20 x 4 mm BITS



39,00* €

*All prices are ex. VAT.

700.1200

HYDRAULIC UNIVERSAL 2 + 3 ARM PULLER SET

- Less risk of slippage due to automatically closing pulling arm
- 8 length positions possible
- Extremely robust spindle with inductively hardened thread
- Lower power usage
- Special tool steel

HYDRAULIC, PRACTICAL, GOOD!



22 pcs



269,00* €

150.1305

STUD EXTRACTOR SET

- Set contents for extensive applications
- For removing of threaded bolts, studding and screws
- No damage of the thread
- Only negligible enlarging of the threaded bolt through special profile extractor pin
- For screws and bolts M5 - M16



25 pcs

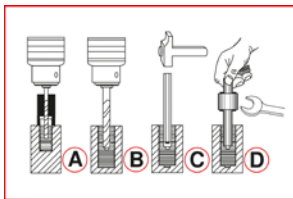

Führungshülse drill guide	Hülse Innen-Ømm guide	vorbohren Ømm pre-drilling	aufbohren re-drilling	Stift pin	Art.Nr. Stift No. Pin	Mutter D nut D	Art.Nr. Mutter nut D	Stift + Mutter pin + nut
150.0501	4,0 / 3,2	3,2	-	3,2	150.0521	SW 10	150.0511	150.0511S
150.0502	4,8 / 3,2	3,2	-	3,2	150.0521	SW 10	150.0511	150.0511S
150.0503	4,8 / 3,2	3,2	4,8	4,8	150.0522	SW 11	150.0512	150.0512S
150.0504	4,8 / 3,2	3,2	4,8	4,8	150.0522	SW 11	150.0512	150.0512S
150.0505	6,0 / 4,8	4,8	6,4	6,4	150.0523	SW 13	150.0513	150.0513S
150.0506	7,0 / 4,8	4,8	6,4	6,4	150.0523	SW 13	150.0513	150.0513S
150.0507	7,0 / 4,8	4,8	8,0	8,0	150.0524	SW 14	150.0514	150.0514S
150.0508	7,0 / 4,8	4,8	8,7	8,7	150.0525	SW 17	150.0515	150.0515S
150.0509	9,0 / 6,5	6,4	8,7	8,7	150.0525	SW 17	150.0515	150.0515S
150.0510	9,5 / 6,5	6,4	8,7	8,7	150.0525	SW 17	150.0515	150.0515S

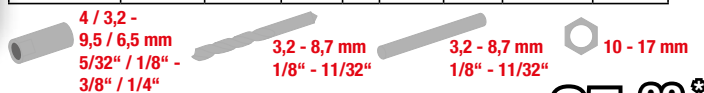

BELONGS IN EVERY WORKSHOP

35,00* €

150.7060

TORX AND HEXAGON SOCKET SCREW EXTRACTOR SET

- Ideal for loosening and opening screws and bolts whose head is damaged or worn off
- Special left-hand cutting thread with tapered cutting edges for Torx screws and specially shaped extractors for hexagon socket screws
- Including TORSIONpower bits for Torx and hexagon socket screws
- Bits with torsion zone for cushioning of the torque peak
- Longer service life



34 pcs

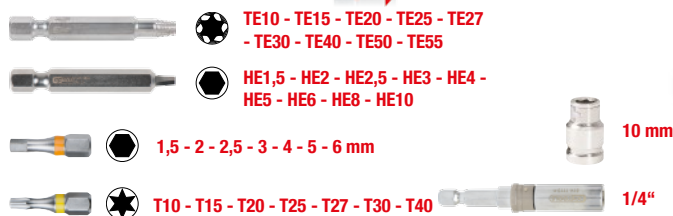

LOOSENS ALL SCREWS

39,00* €

*All prices are ex. VAT.

STANDARD

SPECIAL

HD

Sensational!
The tiniest HD dual camera in the world!

dual camera
0° + 90°
Ø 6.0 mm

dual camera
0° + 90°
Ø 4.5 mm



Ø 6,0 MM

Ø 4,5 MM

Option 1:
with probe Ø 6.0 mm

Option 2:
with probe Ø 4.5 mm



5 pcs



7 pcs

550.7500

199,00 €

550.7530

249,00 €



TECHNICAL DATA:

Screen:	3,5"	Operating time :	approx. 150 min	Rechargeable battery:	1500 mAh	Operating temperature:	-10°C to +60°C
Picture storage format:	JPEG	Connection:	USB 2.0	Battery technologie:	Li-polymer	Storage medium:	microSD
Video format:	AVI	Camera resolution:	1280 (H) x 720 (V)				

Matching accessories!

HD VIDEO SCOPE PROBE, 0°, Ø 3.9 MM

- 6 adjustable mini LED lamps
- Bend radius max. 5 cm
- connectable to HD videoscope 550.7501



HD

550.7506

199,00 €

*All prices are ex. VAT.



WITH TELESCOPIC HANDLE

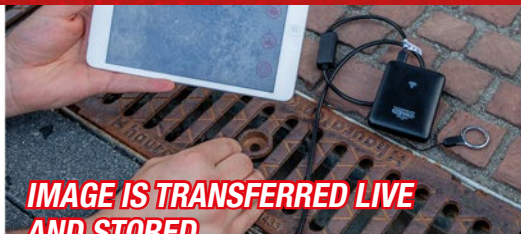

IMAGE IS TRANSFERRED LIVE AND STORED



WATER-PROOFED

6 adjustable mini LED lamps

1.120 MM

60°

Included hook, magnet and mirror

Convenient wifi connection to your smartphone

HD

iOS Android Tablet

USB 2.0

IP67

150 - 1150 mm

WIFI VIDEOSCOPE SET WITH FRONT CAMERA

ARTICLE-NO.	550.7510	550.7540	550.7520
Operating time :	ca. 60 min	ca. 60 min	ca. 60 min
Camera resolution:	1600 x 1200 (YUV), 1280 x 720 (photograph) = 2.0 mega pixel	1600 x 1200 (YUV), 1280 x 720 (photograph) = 2.0 mega pixel	1600 x 1200 (YUV), 1280 x 720 (photograph) = 2.0 mega pixel
Battery technologie:	Lithium-ion	Lithium-ion	Lithium-ion
Head Ø:	5,5 mm	6,0 mm	3,9 mm
Camera angle:	0°	0 + 90°	0°
Included hook, magnet and mirror	✓	✗	✓

7 pcs

Ø 5,5 MM

550.7510

79,00* €

4 pcs

DUAL

Ø 6,0 MM

550.7540

99,00* €

7 pcs

Ø 3,9 MM

550.7520

139,00* €

STANDARD

12V SPECIAL

150.4217

WORKSHOP CABLE REEL

- Extra strong, automatic return mechanism
- 180° freely revolving
- Loadable when coiled: 1000 W
- Loadable when uncoiled: 3000 W
- Metal wall reinforcement rail 205 mm

NO MORE TANGLED MESS OF CABLES!

Cable length: 15 metre

Connection cable 1.5 m

119,00* €

150.9205

MEASURING CUP SET

- Configuration of practical measuring cup sizes
- Break-resistant
- Resistant to oil, petrol and acid
- With handle and spout
- PE (polyethylene)

Scales: L/ml, cups, Oz, quart

500 ml

1000 ml

250 ml

THREE SIZES, ONE PRICE

7,50* €

150.9240

FUNNEL SET

- Configuration of practical funnel sizes
- Break-resistant
- Resistant to oil, petrol and acid
- Grip strap for convenient use
- HDPE (high density polyethylene)

5 pcs

Ø 150 mm

Ø 115 mm

Ø 95 mm

Ø 75 mm

Ø 50 mm

9,50* €

*All prices are ex. VAT.

TOP PERFORMANCE FOR A LOW PRICE!

515.1315

THE MINIDEVIL HIGH PERFORMANCE IMPACT WRENCH

- Easy operation
- 3 stage torque adjustment
- High performance jumbo mechanism
- Long service life
- Ultra light aluminium housing



EXTREMELY SMALL



1084 Nm

1,2 KG

TECHNICAL DATA:

Max. screw size:	M 16
Air consumption:	169 l/min
Operating pressure:	6,3 bar (90 psi)
Min. tube diameter:	3/8" - 10 mm

79,00 €*

515.1200

THE DEVIL HIGH PERFORMANCE IMPACT WRENCH

- Easy operation
- 3 stage torque adjustment
- High performance double hammer mechanism
- Long service life
- Ultra light aluminium housing



EXTREMELY STRONG



1600 Nm

2,1 KG

TECHNICAL DATA:

Max. screw size:	M 16
Air consumption:	169 l/min
Operating pressure:	6,3 bar (90 psi)
Min. tube diameter:	3/8" - 10 mm

69,00 €*

*All prices are ex. VAT.

515.1270

MINIMONSTER HIGH PERFORMANCE PNEUMATIC IMPACT WRENCH

- Easy operation
- High performance double hammer mechanism
- Long service life
- Ultra light Aluminium housing



1390 Nm

1/2"



515.1210

MONSTER HIGH PERFORMANCE PNEUMATIC IMPACT WRENCH

- With practical clockwise and anticlockwise switch
- Easy operation
- High performance double hammer mechanism
- Long service life



1690 Nm

1/2"

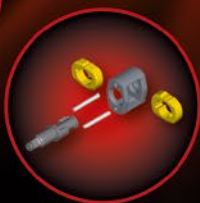

129,00 €

STANDARD

12V SPECIAL

*All prices are ex. VAT.

515.1150

MINIMONSTER XTREME LIGHT HIGH PERFORMANCE PNEUMATIC IMPACT WRENCH

- With practical clockwise and anticlockwise switch
- High performance double hammer mechanism
- Long service life
- ultra light composite housing

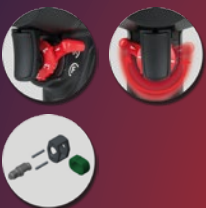

The AGR quality cachet (Aktion Gesunder Rücken - Campaign for Healthier Backs). Certified and recommended by Association Forum Healthy Back - Better Living and Federal Association of German Back Schools. More information: AGR e.V. Stader Str. 6, D - 27432 Bramenwerde, Phone +49 4761/92 63 580, www.agr-ev.de



1390 Nm

~1 KG



149,00* €

TECHNICAL DATA:

Max. screw size:	M 16
Air consumption:	135 l/min
Operating pressure:	max. 6,3 bar
Min. tube diameter:	3/8" - 10 mm



SUPERMONSTER HIGH PERFORMANCE PNEUMATIC IMPACT WRENCH

- With four-stage torque adjustment for tightening and loosening
- Easy operation
- High performance double hammer mechanism
- Long service life



OUR POWERHOUSE

3.405 Nm



>6,7 KG

from 749,00* €

TECHNICAL DATA:

Max. screw size:	M 38
Air consumption:	283 l/min
Operating pressure:	max. 6,3 bar (90 psi)
Min. tube diameter:	3/4" - 19 mm

Item no	■	kg	€
515.3250	3/4"	6,70	€ 749,00
515.3270	1"	6,75	€ 749,00
515.3260	3/4"	7,76	€ 799,00
515.3280	1"	7,82	€ 799,00



AUTOMATIC PNEUMATIC HOSE REEL

- With wall mounting bracket
- For pneumatic and water
- Drum 180° freely tiltable by means of wall mounting
- Automatic hose return
- Impact resistant plastic housing



NO MORE STUMBLING TRAPS!

TECHNICAL DATA:

Connection thread:	3/8" - 10 mm
Max. pressure:	20,0 bar
Tube diameter:	10,0 mm
Hose length:	15 + 1,5 m



515.3440 99,00* €

TECHNICAL DATA:

Connection thread:	1/2" - 13 mm
Max. pressure:	20,0 bar
Tube diameter:	13,0 mm
Hose length:	15 + 1,5 m



515.3445 159,00* €



*All prices are ex. VAT.

Highlights for the workshop

150.4435

PERFECTLIGHT 5 + 1 INSPECTION LAMP 100 LUMEN

- Ideal for very long network independent working
- powerful spot LED
- extremely powerful light COB front LED
- three light modes: two brightness levels and a spot
- Ingress protection according to IP20



SPLASH PROOFED



9,50* €

TECHNICAL DATA:

Illumination period max:	3 hour
Light current max.:	100 lumen
Working temperature:	-10° / +40°C

150.4370

PERFECTLIGHT TORCH 85 LUMEN

- Ideal for smock and shirt pockets
- 25 m headlight range
- 5 - 10 hours lamp duration
- Includes 2 x AA 1.5 V batteries
- Ultra-light and impact resistant aluminium housing



15,00* €

TECHNICAL DATA:

Illumination period max:	10 hour
Light current max.:	85 lumen
Working temperature:	-10° / +45°C

150.4495

MOBILE COB LED WORKSHOP HAND LAMP, FOLDABLE

- Ideal for very long network independent working
- 3 Watt COB LED + 1 x LED Head light
- Housing body covered with high quality rubber
- Ingress protection according to IP20
- Shock and impact resistant

180° FOLDAWAY MAGNETIC STAND



9,50* €

TECHNICAL DATA:

Illumination period max:	3,5 hour
Lumen:	150 / 60 lumen
Working temperature:	-17° / +55°



UV LIGHT: PAGE 33

*All prices are ex. VAT.

STANDARD

12V SPECIAL



BENCH VICE

- With swivel base
- Absolutely parallel with adjustable centric drive
- Extra high possible clamping jaws shaped by large embossed casting
- Large anvil for straightening and compression work
- Induction hardened jaws and anvil



Item no	Clamping range mm	Jaw length	
914.0004	120,0	4"	€ 129,00
914.0005	140,0	5"	€ 139,00
914.0006	170,0	6"	€ 149,00
914.0008	200,0	8"	€ 179,00

LARGE CLAMPING RANGE

from **129,00*** €



150.9239

WATER CAN

- For a wide range of uses
- Break-resistant
- With 2 carry handles
- Pouring spout enables clean emptying
- Suitable for water and coolant fluid



9L
17,50* €



PRESSURE PUMP VAPORISER

- Made from high-quality polyethylene
- For various chemicals such as brake cleaner, detergents, releasing and cleaning fluids etc.
- Adjustable and closable brass spray head
- Viton® seal
- Suitable for overhead work

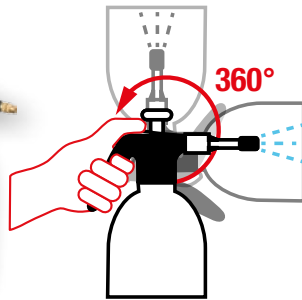

Item no	Volume in litre	
150.8251	1	€ 8,50
150.8252	2	€ 9,50

from **8,50*** €

800.0960

ALUMINIUM WORK PLATFORM

- Skid proof profile on the platform stage
- Large platform for safe standing
- Safety clips for added security
- Easy to store as the unit is fully collapsible
- The gripped plastic feet protect the surface and add stability



SUPER SAFE SUPER PRACTICAL

75,00* €



500.8100

UNIVERSAL TELESCOPIC-MULTI-PURPOSE TROLLEY WITH ROLLERS

- Ideally for the car body restoration, panel spraying area or for windshields
- Universal application the all rounder both height and width adjustable
- After use space saving folding away
- Rubber underside to prevent damage to the paintwork and other panels
- Capacity up to 100 kg

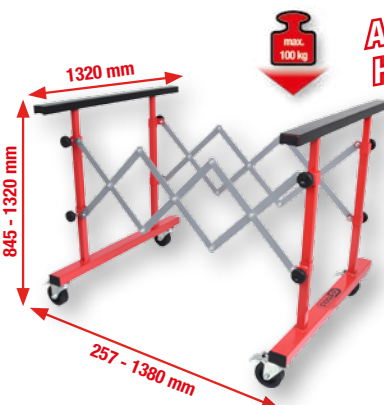

ADJUSTABLE FOR HEIGHT AND WIDTH



149,00* €



500.8030

MOBILE AND HEIGHT ADJUSTABLE STOOL

- Robust and mobile stool
- Storage area for the protection of tools and small parts
- Washable cushion
- Hydraulic height adjustment
- Maximum capacity up to 90 kg



59,00* €

*All prices are ex. VAT.

500.8002

MAT WITH HANDLE

- Guarantees safety-conscious working on a flat surface
- Moisture and dirt resistant
- Work garments and knees stay dry, clean and protected
- Petrol and oil resistant



EXTREMELY COMFORTABLE



35,00* €

PROTECTION MAT

- Guarantees safety-conscious working on a flat surface
- Moisture and dirt resistant
- Work garments and knees stay dry, clean and protected
- Petrol and oil resistant



500.8040



500.8045

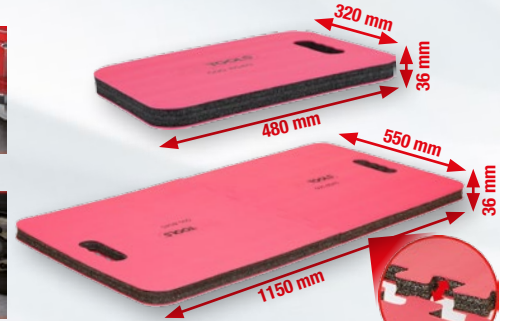

Item no	Length mm	Width mm	Price
500.8040	480,0	320,0	€ 9,50
500.8045	1150,0	550,0	€ 35,00

from 9,50* €

500.8011

DRIVABLE STRETCHER AND FOLDING SEAT

- For the use of lying and sitting
- Interlocking mechanism against accidental loosening
- Padded execution for fatigue free working
- Washable cushion
- Shallow depth for comfortable working



FITS ALWAYS

49,00* €

500.8090

MOBILE SEAT

- Shaped arm areas for optimal movement freedom
- Includes safe tool recesses
- Easy to clean
- Maximum capacity up to 120 kg



69,00* €

160.0342

UNDERHOIST STAND WITH PEDAL

- Ideal for all work when extra support is needed
- Stable trapeze threaded spindle
- Smooth-operating with axial bearings
- Foot pedal for precise adjustments (20 mm)
- The ideal work shop assistant in many situations

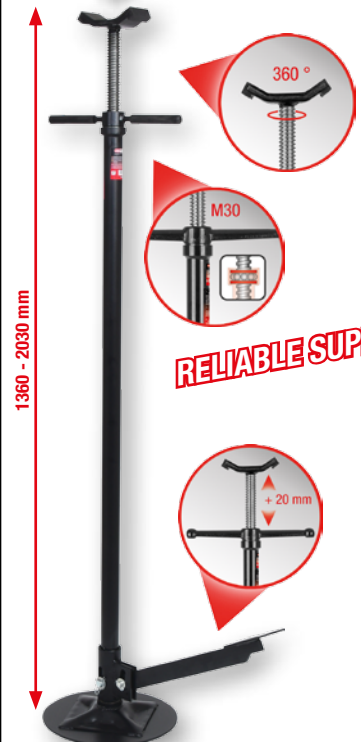
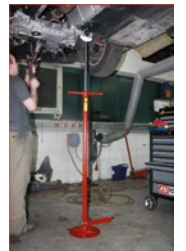

RELIABLE SUPPORT

99,00* €

*All prices are ex. VAT.

STANDARD

SPECIAL

865.0201

XXL WORKBENCH WITH 3 DRAWERS AND 1 DOOR

- High level of stability
- High stability due to all metal parts being welded
- Lockable door
- Central locking system on all drawers through the cylinder lock
- Drawers with non-slip rubber mat



XXL

Big bench for big jobs

999,00* €



140.3050

NEEDLE FILE SET IN SOFT PLASTIC STORAGE CASE

- High cutting rate
- With solid plastic handle
- For working in the area of the fine mechanics
- Special tool steel

12 pcs

- 5,0 x 1,0 mm
- 5,0 x 1,0 mm
- 3,0 mm
- 3,0 mm
- 5,0 mm
- 5,0 mm
- △ 3,0 mm
- △ 2,0 mm
- 2,0 mm
- △ 5,0 mm
- 5,0 mm
- 5,0 mm



145 mm

7,50* €



140.3000

WORKSHOP FILE SET

- DIN 7261 form B, C, D, E, F
- Second cut
- 200 mm long
- Two component handle
- Special tool steel

5 pcs

Includes one flat, halfround, round, square and triangular file with a length of 200 mm and second cut

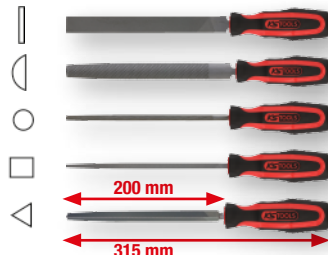

200 mm

315 mm

25,00* €



907.2105

FOLDING KNIFE WITH LOCKING MECHANISM

- Teflon coated blade
- Blade fixator folded out
- Non slip handle with finger recesses
- Ideal for mechanics

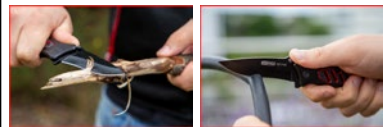

OUR BEST SELLER

8,50* €



907.2225

FOLDING KNIFE WITH LOCKING MECHANISM

- Blade with coating
- Blade fixator folded out
- Easy and handy to use
- Anodised aluminium handle
- with belt clip



200 mm



9,50* €

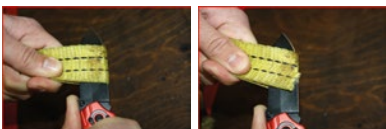

907.2220

CLASP KNIFE WITH LOCK AND BELT CUTTER

- Blade with coating
- Blade fixator folded out
- integrated belt cutter on the handle
- Glass breaker at handle end
- Easy and handy to use



210 mm



9,50* €



*All prices are ex. VAT.

907.2240

SCRAPER

- Ideal for removing of stickers, seal and glue residues
- With easily interchangeable and retractable blades
- With reinforcement eyelet
- Scraper blade retractable via spline end for protection
- With metal housing



accessories:

5 PIECES

911.8127 Replacement scraper blades € 3,00

INCLUDES 1 BLADE

5,00* €

907.2200

KNIFE SCRAPER SET

- Ideal for removing of stickers, seal and glue residues
- Simple blade change by loosening the knurled thumb screw on the chuck
- Practical storage system for changeable blades
- Suitable for many different application due to the wide range of blades
- Professional universal knife with aluminium housing



27 pcs



12 - 16 - 20 mm

25,00* €

162.0370

PIN PUNCH SET

- Quenched and tempered
- Tip can be re-sharpened
- Shaft with gold coated lacquer
- Chrome molybdenum
- In metal storage box



6 pcs

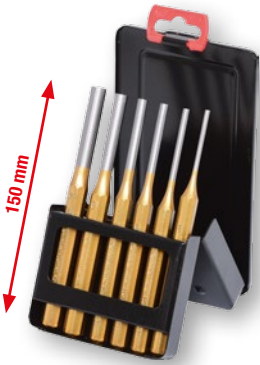

- Ø 10 x 3 -
- Ø 10 x 4 -
- Ø 10 x 5 -
- Ø 10 x 6 -
- Ø 12 x 8 -
- Ø 12 x 10 mm

25,00* €

MICRO FINE WOVEN GLOVES - BLACK

- Very comfortable design and fit
- Especially breathable fabric
- With PU reinforced gripping palm
- Ideal for working with small parts
- Printed logo



12 PAIR

Item no

310.0470	9	€ 19,00
310.0475	10	€ 19,00
310.0480	11	€ 19,00

from 19,00* €

LEATHER MECHANIC GLOVE

- Ideal for working with small parts secure grip
- Inner palm - synthetic material leather
- With anti-vibration protection
- With elasticated wrists
- With hook and loop fastener



Item no

310.0250	9	€ 17,50
310.0255	10	€ 19,00
310.0260	11	€ 19,00

from 17,50* €

310.0195

WELDERS PROTECTIVE HELMET

- Turns fully automatically from bright after dark as soon as the light arch is ignited
- Due to high quality solar cells battery replacement is no longer require
- Equipped with a sensitivity and delaying switch for switching between dark and light to prevent welders blindness when welding at high amp capacity
- Quick switching is possible when changing from seam to spot welding
- Complete neck protection



69,00* €

310.0110

GLASSES - TRANSPARENT

- Practical for spectacle wearers
- With ventilation holes for clear visibility
- With firm frame
- With ear clip
- Polycarbonate lens



3,00* €

*All prices are ex. VAT.

150.1628

DOOR HANDLE REMOVAL TOOL FOR VAG

- with special profile
- for loosening the locking hook which is difficult to access with door handles without a closing cylinder
- Required to remove the door handle
- Two component handle
- Chrome vanadium

Application range: Volkswagen Arteon >2017, Caddy >2016, Golf Sportsvan >2015, Passat >2015, Tiguan >2016, Touran >2016 and Audi Q2 >2016

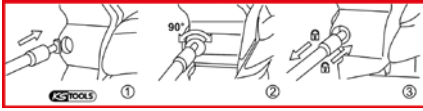

15,00*
€



911.8181

PUSH PIN PLIERS, STRAIGHT

- for the removal of reusable plastic rivets, push rivets and clips
- removes the pin and anchor without damage
- angled tips
- Self opening
- With PVC dipped handle

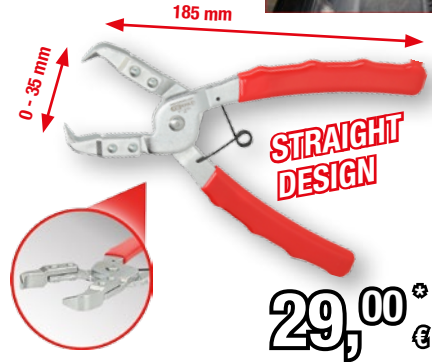

29,00*
€



911.8182

PUSH PIN PLIERS, ANGLED

- for the removal of reusable plastic rivets, push rivets and clips
- removes the pin and anchor without damage
- angled tips
- Self opening
- With PVC dipped handle

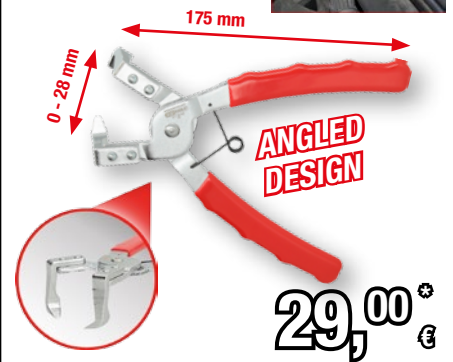

29,00*
€



150.1010

BATTERY-OPERATED PLASTIC REPAIR SET

- Suitable for the repair of cracks or similar damage to plastic parts (from 1 mm thick)
- Also for plastics with a glass fibre content of max. 40%
- Battery operated, mains independent working
- Heating rod holder for different repair clamps with Ø 0.6 and 0.8 mm

Application range: Bumpers, panels, covers etc.

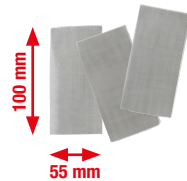
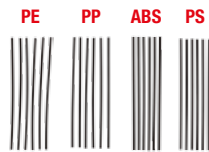
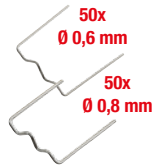

134
pcs

TECHNICAL DATA:

Operating time :	ca. 90 min
Working temperature:	0°C up to +500°C
Charging time:	3-4 hours
Capacity:	30 Watt

149,00*
€

115.5050

HOSE CLAMP PLIER SET

- For simple clamping of flexible for hoses from 15.9 mm (5/8") up to 60.0 mm (2.3/8")
- The hose is a broad area squeezed against the stable support surface, damaging the hose is avoided
- Prevents petrol, oil, water and radiator anti-freeze from escaping during maintenance work
- Ideal for use in passenger cars, vans and large vans, commercial vehicles, tractors, agricultural machinery, construction machinery and industrial applications
- Heat resistant up to 160 °C



3
pcs

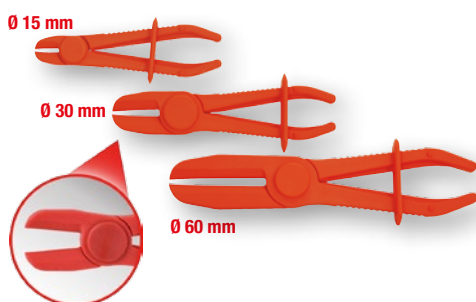

19,00*
€

550.1285

REFRACTOMETER - OPTICAL TESTER FOR BATTERY FLUID, ANTIFREEZE AND ADBLUE® ADDITIVES

- For the quick and accurate testing of the acidity of the battery fluid, the anti-freeze content and the AdBlue® additives
- Can also be used for coolant and windscreen wiper fluid
- Also suitable in ambient temperatures of less than 10°C
- High quality design made from aluminium

*AdBlue® is a registered trademark of the Verband der Automobilindustrie e.V (VDA).



EVERYTHING IN
VIEW!



85,00*
€

515.1980

PNEUMATIC CLEANING GUN

- Ideal for professional cleaning of cushions, door pillars, ventilation channels, carpets, foot mats, fabric seats etc.
- Unique, cyclonic, ball bearing mounted rotation cleaning technology
- For all possible surfaces, cleaned damp or dry
- Also suitable for hard-to-reach places, e.g. between seats and seams
- Cleaned surfaces also dry extremely quickly thanks for the fine misted cleaning solution



FOR ALL SURFACES

1.000 ML



1/4"PT



TECHNICAL DATA:

Operating pressure:	max. 6,3 bar (90 psi)
Min. tube diameter:	3/8" - 10 mm

125,00* €

515.1935

PNEUMATIC CLEANING GUN SET WITH SUCTION HOSE

- Ideal for professional cleaning of cushions, door pillars, ventilation channels, carpets, foot mats, fabric seats etc.
- Pneumatic-operated with simple handling
- Unique, cyclonic, ball bearing mounted rotation cleaning technology
- For all possible surfaces, cleaned damp or dry
- Includes 360° rotating and 30° angled ball joint and plug nipple



1.000 ML

FOR ALL SURFACES



1/4"PT

1,8 m

Ø32 - 42 mm



3 pcs

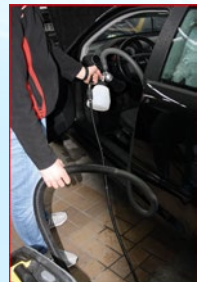

TECHNICAL DATA:

Operating pressure:	max. 6,3 bar (90 psi)
Air consumption:	120 l/min
Min. tube diameter:	3/8" - 10 mm

159,00* €

150.9565

RIVET GUN ADAPTER

- Blind rivet attachment for drills, screwdrivers and cordless screwdrivers with clockwise and counter-clockwise rotation
- 11 Nm torque and a speed of max. 1000 rpm are required for use
- Enormous time and cost saving
- Simple handling
- made from carbon steel with plastic housing

Blind rivets, aluminium: 2.4 - 3.2 - 4.0 - 4.8 mm
Blind rivets, steel: 2.4 - 3.2 - 4.0 mm



19,00* €



150.3010

LAYER THICKNESSES MEASURING INSTRUMENT

- For fast measurement of coatings
- For coatings on aluminium, iron and non-ferrous metals
- Ideally suited to the disclosure of accident damage
- Digital display with lighting
- One hand operation



TECHNICAL DATA:

Readout:	3.1/2" LCD readout
Loading gage "Strength":	0-40 mils (0-1000 µm)
Operating settings:	0°C - 50°C (32°F - 50°F) < 75% air humidity

155,00* €

*All prices are ex. VAT.

150.1930

MASTER COOLING SYSTEM DIAGNOSTIC SERVICE SET

- Ideal compilation set for testing the cooling system as well as the pressure caps
- Quickly find leaks in the cooling system, e.g. cylinder head seals, cooling unit, water pumps, hoses etc.
- Suitable for almost all common vehicles with water-cooled engines, e.g. from Europe, Japan, USA etc.
- Quick and efficient use

0 - 200 °C
0 - 400 °F

1600 mm

max. 76 cm

0 - 2,5 bar

R123 R123 #1 #2 #3 M50 x 2,5 M42 x 3
R124 R125

M58 x 3 M62 x 3 M48 x 4 M45 x 3 M50 x 2,5 M60 x 4 M52 x 3

M48 x 2,5 M42 x 2,5 M50 x 3 M46 x 3 M34 x 2,5 75 mm

25 pcs

269,00* €

150.9388

3-JAW FUEL GAUGE AND PUMP SENDER COLLAR WRENCH

- Ideal for releasing and tightening the fuel filter locking ring from the tank sender to the fuel tank
- Makes possible simple and time-saving work
- No damage to the ring by the tool
- Makes work in tight gaps possible
- Less space required



16 mm

87 - 170 mm

69,00* €

550.1136

FLEXIBLE INSPECTION MIRROR WITH LIGHTING

- Ideal for very long network independent working
- LED light source
- For visual monitoring and troubleshooting
- Double ball joint
- Approx. 60 hours lamp duration



APPROX. 60 HOURS LAMP DURATION

260 - 760 mm

9,50* €

150.3610

RADIAL SHAFT SEAL REMOVER SET

- For the removal of radial shaft seals and small bearings
- For hard to reach places too
- Quick and easy to remove
- Using the blow weight the thread tip is hit into the radial shaft seal and turned by hand and then removed with the blow weight
- Long durability through hardened leverage



LORD OF THE SIMMERINGS



300 mm

320 g

380 mm

2 pcs

35,00* €

*All prices are ex. VAT.

700.1280

UNIVERSAL CRANK SEAL REMOVER AND INSTALLER SET

- Suitable for the damage-free and correct assembly and removal of radial shaft seals and drive shaft circlips
- For tight-fit application on engine shafts such as crank shaft, cam shaft or intermediate shaft
- Can used universally for radial washers in diameters from 21.5 mm to 64.0 mm
- time- and cost-efficient

Application range: Extensive universal tool including pressing tools for radial washers in diameters from 21.5 mm to 64.0 mm on almost all vehicles

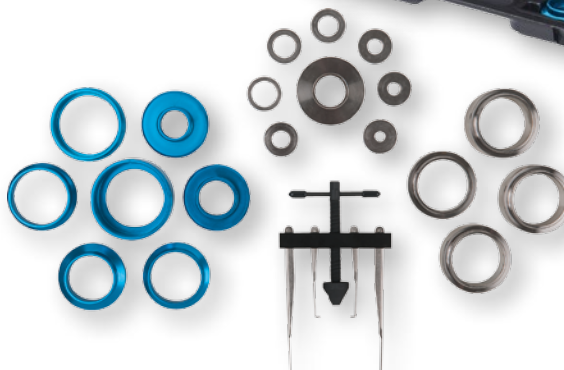
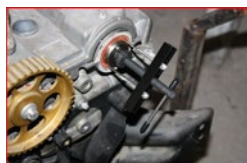

24 pcs

149,00* €

913.1415

SPECIAL NUTS EXTRACTOR SET

- For loosening and unscrewing of fixed nuts with damaged "round turned" heads
- Special, left-handed thread with 6 conical tapered cutting edges
- Very flat compact and robust execution
- The drive can be used alternatively with a socket or ring spanner



THE PROBLEM SOLVER



For up to 80% rounded screws!



12 pcs

19,00* €

150.1910

CO2 CYLINDER HEAD LEAK TESTING SET

- For the locating of leaks on combustion engines
- Rational and dependable finding of cracks and leakages
- Potential CO2 content in the coolant solution is detected
- Ideally suited for the cylinder head, cylinder head seals and engine block
- For all current vehicles with water cooled engines (Gas, Diesel and Petrol)

COMPLETELY HAPPY



8 pcs

129,00* €

*All prices are ex. VAT.

STANDARD

12V SPECIAL

911.1740

BELT DISC COUNTER HOLD TOOL FOR MERCEDES

- Special profiles allows for counter holding when releasing or securing the crank shaft central screw
- short lever
- carbon steel

Application range: Mercedes (engine code: M271)



89,00* €



150.2233

SPECIAL RELEASE TOOL FOR HENN® CLAMPS

- universally suitable for vehicles with HENN® clamps
- suitable for unlocking or loosening clamps on air or coolant hoses
- head adjustable with a grip up to 90° for harder-to-reach areas
- With PVC dipped handle



17,50* €



405.0155

SPECIAL INJECTOR WRENCH SET

- 6 point
- Special length and design
- Drive and output are on one axis and thus allow controlled tightening of the screw connection
- Opening allows 180° rotation



4 pcs

Application range: BMW, Kia, Hyundai / Mercedes



109,00* €

405.0070

INJECTION NOZZLE EXTRACTOR SET FOR FORD

- ideally suited for dismantling injectors on Ford EcoBoost GDI engines
- enables short and intensive impact through impact weight
- Sturdy design
- Cylinder head does not work against the thrust bearing



3 pcs

Application range: Ford EcoBoost GDI 1.0L to 2.0L



159,00* €

400.9075

DIESEL PUMP SPROCKET PULLER FOR VAG

- ideal for loosening the high pressure pump sprocket from the shaft
- 15 mm hexagonal pressure screw and 24 mm hexagonal retaining screw
- For manual operation
- Sturdy design



Application range: Volkswagen Golf >2013, Audi A3 >2013, Škoda Rapid >2012, Octavia, >2013, Fabia 2014, Superb >2015, Kodiaq 2016, Seat Alhambra >2011, Ibiza 2008, Leon 2013 and Ateca with 1.4-, 1.6- and 2.0 litre TDI engines



69,00* €

500.7505

PENCIL TYPE IGNITION COIL PULLER

- Perfect for the fast and safe disassembly of pencil-type ignition coils
- Prevents damage to the coil and on the housing
- Phosphate finish
- Chrome vanadium



Application range: 1,2 I / 1,4 FSI + 2,0 I TFSI Volkswagen Golf (>2013), Audi A3 (>2013), Seat Leon (>2013), Škoda Octavia (>2013)



39,00* €

150.3305

V-RIBBED BELT TOOL

- Suitable for the assembly and disassembly of the elastic V ribbed discs
- Quick, problem-free and correct changing of the belt
- No damage to the pulley wheel and the belt
- Minimal force required
- Special tool steel



19,00* €

*All prices are ex. VAT.

911.3999



SPECIAL SPARK PLUG SOCKET FOR BMW WITH JOINT

- Double hexagon profile allows the pickup of hexagon and 12-point spark plugs
- With swivel head for hard to reach spark plugs
- Holding rubber facilitates the assembly and disassembly
- Avoids damage to the ceramic

Application range: BMW 1er (E81 / E87), 3er (E90) and 5er (E60) with BMW N43 engines, because the spark plugs are installed at an angle of > 5°



15,00* €

500.7325



SPECIAL GLOW PLUG AND SPARK PLUG SOCKET SET WITH JOINT

- 6- and 12-sided
- Double hexagonal profile (14 mm spark plug socket) makes it possible to grasp hexagonal and double hexagonal spark plugs
- Extra slim design
- with swivel head for hard-to-reach spark plugs and glow plugs
- with rubber mount for holding spark plugs and glow plugs



8 mm 9 mm 10 mm 12 mm 14 mm 16 mm
1/4" 3/8"



79,00* €

11 pcs

400.0060

BELT PULLEY ALIGNMENT TOOL SET

- ideal for checking and aligning V-ribbed belt pulleys before installing the new belt
- reduces wear on belts and belt pulleys
- manually adjustable steel alignment rod
- Main housing with magnet

Application range: incorrectly aligned belt pulleys, defective guide pulleys or water pumps, air-conditioning compressors and overrunning alternator pulleys

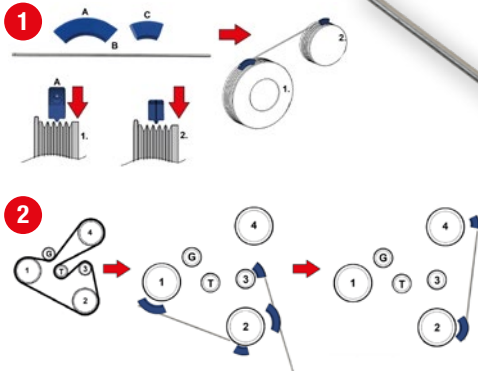
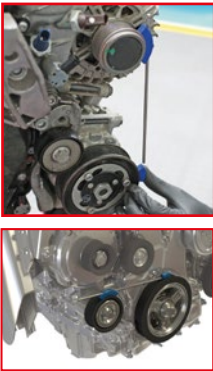

Simply innovative



3 pcs

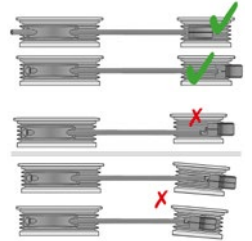

49,00* €

150.3170



UNIVERSAL BELT PULLEY PULLER 2 ARM

- For grooved belt pulleys
- Draw off arms with locking device
- Clamping yoke compresses the legs firmly
- Prevents slipping
- Less space requirement through compact method of building

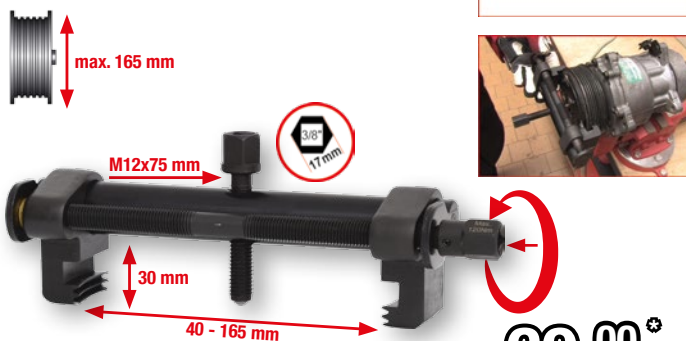

69,00* €

104.5050



RATCHET PIPE CUTTER

- for the fast and problem free cutting off of pipes with 2 support rolls and 3-handle ratchet mechanism
- very good parallel cutting due to the width-accurate cutting is guaranteed
- Cutting depth max. 3 mm
- Robust ratchet mechanism



IMPROVED CUTTING!



129,00* €

*All prices are ex. VAT.

550.1173

LED COB STRIPE INSPECTION LAMP 190 LUMENS WITH UV SPOT LED

- Ideal for very long network independent working
- extremely powerful light COB front LED
- Powerful UV spot LED
- two light modes: one brightness level and a UV spot
- 2 light flux strengths: COB front 190 lumens and spotlight 60 lumens light flux



12,50* €

150.3075

12-42 V DETECTOR FOR LOCATING SHORT CIRCUITS, CABLE BREAKS AND LEAKAGE CURRENT

- For the quick, easy and proper searching for short circuits, cable faults and leakage current without having to puncture wires
- Saves a great deal of time, because removing interior lining, carpeting and trim on the vehicle can be reduced to the essentials
- For locating electrical components in the vehicle
- For testing and detecting temporarily interrupted connections ("loose connections")
- The transmitter is connected to the circuit to be tested with the insulated crocodile clamps via the fuse box



2 pcs



HAPPY END INSTEAD OF SHORT CIRCUIT



59,00* €

550.1649

12V / 24V BATTERY-, CHARGING- AND STARTING SYSTEM ANALYZER WITH INTEGRATED PRINTER

- Suitable for 12 volt batteries (lead acid, gel, wet cell, MF, VRLA, calcium, AGM and deep cycle batteries)
- For the quick and simple determination of battery efficiency while taking the temperature compensation into account
- Checks the battery condition, charge status, internal resistance, cold start current value
- With verification function for the starter battery, starter and load circuit measurement
- Avoidance of an overload of the battery through too long of a measurement time



WITH PRINTER



INCLUDES 3 ROLLS OF PRINTING PAPER

FOR ALMOST ALL BATTERIES

299,00* €

TECHNICAL DATA:

Readout:	digital
Work area CA / MCA:	40-2.000 CCA
Work area CCA:	40-2.000 CCA
Work area DIN:	40-2.000 CCA
Work area EN:	40-2.000 CCA
Work area IEC:	40-2.000 CCA
Work area JIS#:	40-2.000 CCA
Work area SAE:	40-2.000 CCA
Operating temperature:	+0°C to +55°C
Frequency range:	100 Hz
Working range:	9-36 V
Display accuracy:	+/- 0,5 Megaohm
Voltage range:	9-36 V

*All prices are ex. VAT.

150.1025

CABLE ROUTING AID SET

- prevents damage to cable insulation
- helps the user to thread or pull out cables or probes if there are obstacles or components with sharp edges
- different diameters and lengths provide various options for adaptation
- rounded opening at the handle end allows cables or probes to be handled easily without causing damage
- with 4 different attachments



5 pcs



49,00* €

150.0939

CABLE THREADING ASSISTANCE

- ideal for retraction or laying of cables or lines
- with rounded head (Ø 5 mm), the pulling aid can easily be pushed through the tubes
- with eye for fastening the cable or line
- Shape is maintained and can be altered at any time
- Free malleable, therefore can be adapted for extremely tight spaces

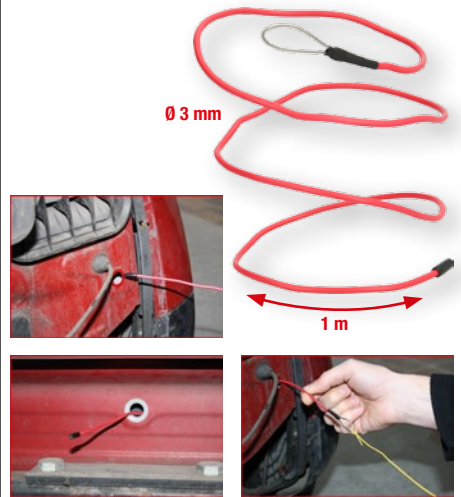

9,50* €

117.1890

TOOL SET WITH INSULATED TOOLS FOR HYBRID AND ELECTRIC VEHICLES

- Insulated to IEC 60900
- In a classy aluminium case
- Special tool steel



43 pcs

AN EXCITING CASE



- | | | |
|--------------|---------------|-------------------|
| 240 mm | [Screwdriver] | T30 |
| 215 mm | [Screwdriver] | T25 |
| 210 mm | [Screwdriver] | T20 |
| 185 mm | [Screwdriver] | PH1 |
| 165 mm | [Screwdriver] | PH2 |
| 165 mm | [Screwdriver] | PH3 |
| 180 mm | [Screwdriver] | 2,5 mm |
| 10 | [Screwdriver] | 3,0 mm |
| 25 | [Screwdriver] | 3,5 mm |
| 3/8" | [Screwdriver] | 4,0 mm |
| 3/8": 150 mm | [Screwdriver] | 3/8": 6-7-8-9-10- |
| 3/8": 250 mm | [Screwdriver] | 11-12-13-14-16- |
| | | 17-18-19-20-22 mm |
| | | 3/8": M8 |
| | | 3/8": M10 |
| | | 3/8": M12 |



499,00* €

*All prices are ex. VAT.

STANDARD

12V SPECIAL

150.9275

UNIVERSAL TRANSMISSION OIL FILLING SYSTEM SET INCL. 20 PIECE ADAPTER SET

- Ideal for filling transmission, distributor transmission and differentials of different vehicle manufacturers with oil
- Many transmission cannot be filled without this tool
- Optimal for narrow places or hard-to-reach places
- For difficult to access areas

NOW WITH 20 ADAPTERS FOR THE PROS



21 pcs



- Ford 1/8" - 27 NPT
- Universal
- VAG
- VAG, BMW + Mini M10 x 1,0
- Mercedes 722,9, M12 x 1,5
- VAG + Porsche
- VAG CVT M22 x 1,5
- Škoda M18 x 1,5
- VAG + Škoda M30 x 1,5
- Volvo 5/16" - 24 UNF
- Toyota + Lexus M18 x 1,5
- Nissan + Infinity M8 x 1,0
- ATF-VW Passat + Tiguan
- Nissan Juke M12 x 1,25
- Mini Cooper M14 x 1,5
- Nissan M10 x 1,5
- GM M12 x 1,75
- Mercedes 725-9G
- Universal, 300 mm

219,00 €

500.8805

PRESSURISED AIR STAND SPRING COMPRESSOR INCL. ADAPTER PLATE

- Ideal for tensioning spring feet
- Pressurised air support allows for extremely comfortable working
- Secure assembly and disassembly of the shock absorbers with McPherson spring feet system
- Suitable for 95% of all vehicles on the market
- Secure and easy to use



FOR 95% OF ALL VEHICLES



INCL. ADAPTER PLATE

TECHNICAL DATA:

Operating pressure max:	10 bar
Connection thread:	1/4"
Air consumption:	250 l/min
Compression force max:	1.200 kg
Compression stroke:	450,0 mm

1199,00 €

150.9545

SPECIAL SHOCK ABSORBER ASSEMBLY HELP SET FOR SHOCK ABSORBERS WITH REBOUND BUFFER SPRINGS

- For assembly and disassembly of shock absorbers with rebound buffer springs
- Simply remove the entire rebound buffer spring and align securely
- Minimum time needed
- Significantly reduces risks when changing springs or shock absorbers



7 pcs



149,00 €

500.8755

UNIVERSAL TELESCOPIC CENTRE COMPRESSOR SET FOR INTERNAL SPRINGS

- For removal/installation of spiral springs on spring strut and independent multilink suspensions
- Safe removal and installation without dismantling the axle
- New, revised version with longer clamping stroke
- Overload protection with torsion drive element
- Suitable for use on vehicles with very small access bores



9 pcs



TECHNICAL DATA:

Spring force max:	1600 kg
Spring capacity:	95,0 - 220,0 mm
max. Load:	1600 kg



INCLUDED



SAFETY FIRST

299,00 €

*All prices are ex. VAT.

150.1800

ALIGNMENT TOOL SET FOR PASSENGER CAR VEHICLE

- This was specially developed specifically for use on cars and vans with 4 or 5 hole pitch
- Ideal for practical assistance with repairs and assembly of steering and chassis components for motor vehicles
- Ideal for replacement work on shock absorbers, suspension springs and top mount
- Also applicable for the exchanging of tie rod end, tie rod or axle joints
- Optimization of the repair process by eliminating a time consuming and costly alignment



15 pcs

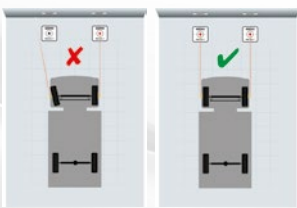

M12 x 1,5 mm

M14 x 1,5 mm



179,00* €

150.1810

ALIGNMENT TOOL SET FOR LIGHT AND HEAVY COMMERCIAL VEHICLE

- Universal application, independently of hole spacing and number of bolts
- For repair work on steering and suspension components
- Restoring of the original wheel adjustment parameters such as toe-in and track width after a repair
- when replacing suspension parts, e.g.: Track rod end (ball joint)

Application range: Use of transporters, trucks, buses, trailers and semi-trailers



21 pcs



M18 x 1,5 mm

M16 x 1,5 mm

M20 x 1,5 mm

M14 x 1,5 mm

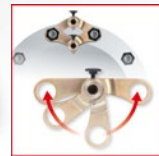
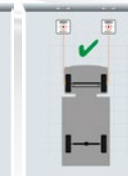

209,00* €

150.1125

SPECIAL AXIAL JOINT WRENCH SET

- For the disassembly of axle joints on the track rods
- For use on square, hexagonal, octagonal and round outside profile
- Gentle removal without damaging the external joint surfaces
- Positive connection
- For narrow spaces

THE KEYS TO SUCCESSFUL REPAIRS



4 pcs



30-35 mm



35-40 mm



40-45 mm

1/2"



1/2" 32 mm

159,00* €

*All prices are ex. VAT.

500.8480

INDUCTION HEAT GUN SET

- For loosening rusted and seized connections
- For loosening "insoluble" glued connections
- Pinpoint heating in seconds
- Heating of components up to max. 790 °C (red-hot)

Application range: Screws, nuts and bolts, exhaust clamps and pipes, lambda probes, running gear, stuck bearings, ball joints, steering (e.g. tracking adjustment screws), chemically micro-encapsulated threaded connections (bonded), warming of bearing housings during dismantling and assembly

IT'S NOT ONLY THE PRICE THAT IS HOT!

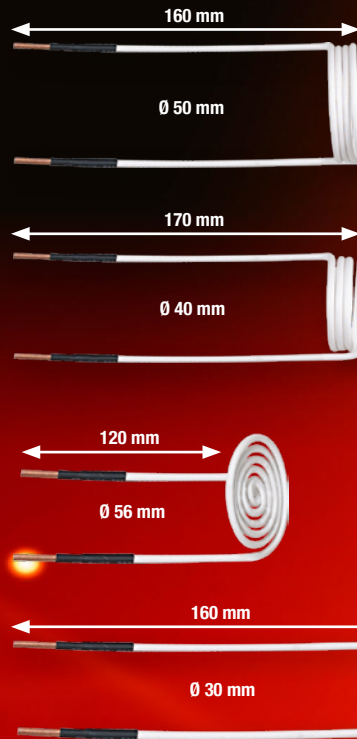

399,00* €



6 pcs

515.3880

VIBRO IMPACT PNEUMATIC CHISEL HAMMER SET

- With non slip soft grip handle
- Ideal for industry
- Efficient, gentle loosening of screw fittings
- With stepless impact regulation
- Vibration dampened

That exerts pressure!

WITH WALL MOUNTING BRACKET

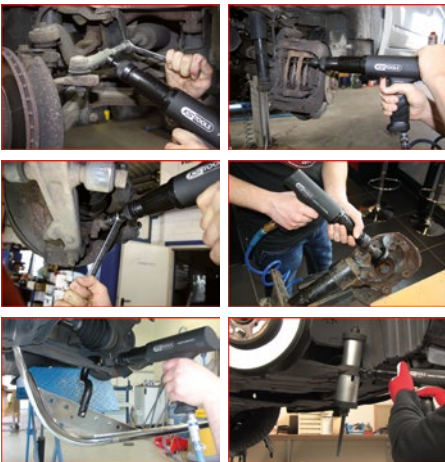

VIBRO-POWER



299,00* €



6 pcs

TECHNICAL DATA:

Chisel holder:	10,2 mm
Operating pressure:	max. 6,3 bar (90 psi)
Air consumption:	114 l/min
Min. tube diameter:	3/8" - 10 mm

*All prices are ex. VAT.

700.1550

PRESS AND PULL SLEEVE KIT

- For the assembly and disassembly of bearings
- Ideally for silent bearings, hydro bearings, bushings, ball bearings, simmer rings etc.
- Universal use for passenger cars, trucks, communal, agricultural and forest vehicles
- Outstanding to use also in connection with workshop press or hollow piston cylinder
- Pressure bearing protects against increased friction during the process

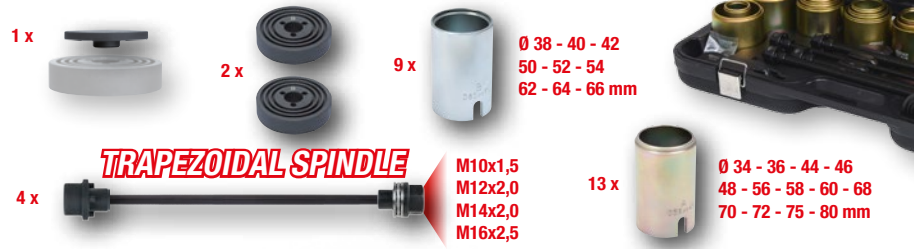

37 pcs

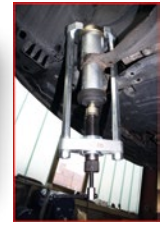

499,00* €

150.1840

RETAINING RING CLAMPING TOOL

- 90° angled
- For the disassembly and assembly of nut caps without lug retainer
- Slip proof
- Chrome vanadium

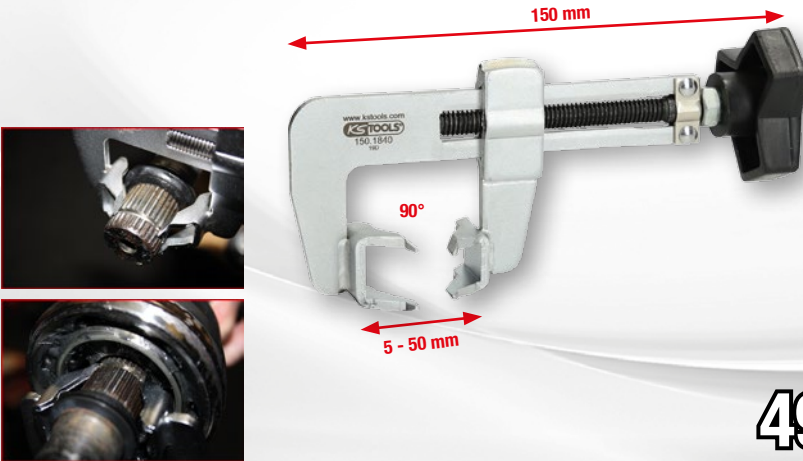

49,00* €

150.1736

12 POINT DRIVE SHAFT IMPACT SOCKET, THIN WALLED

- 12 point
- tapered
- Internal square to DIN 3120 / ISO 1174 with ball reception
- Very robust execution

Application range: for Opel Corsa D, Adam, Mokka; Chevrolet Trax >2013; Fiat 500, Grande Punto, Punto Evo >2005; Ford Ka, Mercedes S-Klasse, BMW, Volkswagen and Jaguar XJ40, XJ181



19,00* €



150.2740

WHEEL HUB HOLDER SET

- ideally suited for secure holding during assembly and disassembly of the drive shaft central screw and the drive shaft screw connection on the gearbox
- Universal usage
- suitable for almost all cars and vans
- suitable for max. M14 wheel bolts / wheel nuts
- In durable plastic storage case

SECURE HOLDING

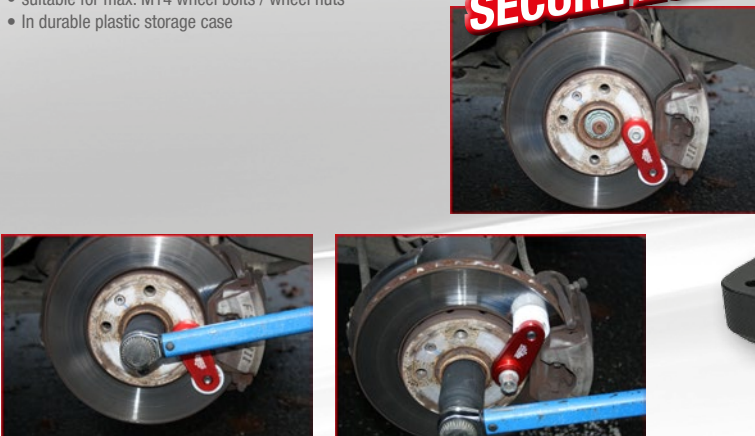

6 pcs

89,00* €

*All prices are ex. VAT.

700.1495

UNIVERSAL AXLE LEVER WITH CHAIN

- Special lever for the correct and protective dismantling and assembly of axle parts
- Different design of wishbones can be pressed down with low effort, safe with flexible chain
- Protective and certain installation and extension
- No second person required
- High power, firm seat and time savings also

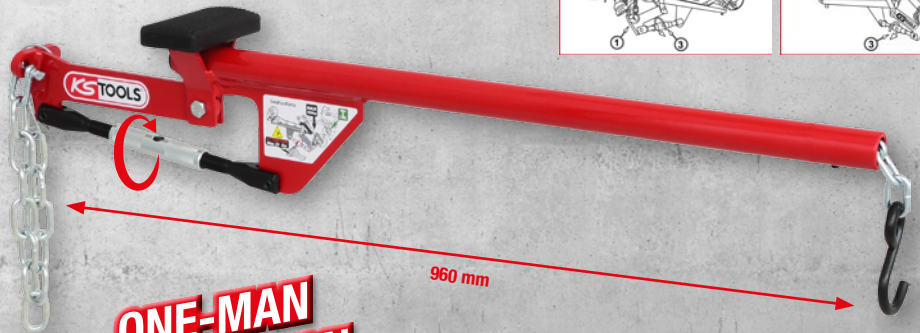
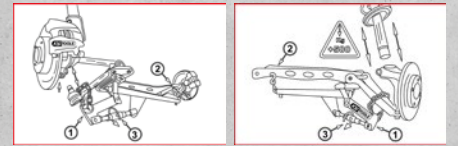

ONE-MAN OPERATION

149,00 €

515.3100

PNEUMATIC ASSEMBLY TOOL FOR CV JOINT BOOTS

- suitable for all universal and original vehicle axle boots
- also suitable for all-wheel vehicles and small transporters
- with 8 extremely robust spreader arms
- Air pressure is regulated through a button
- no additional lubricant necessary



Always on the move



99,00 €

TECHNICAL DATA:

Operating pressure:	max. 8 bar
Min. tube diameter:	3/8" - 10 mm
max. Expansion diameter:	25 - 115 mm

150.1467

THREAD BOTTOM TAP FOR EXTERNAL THREAD M4 - M45

- For re-cutting and cleaning damaged outer threads
- Suitable for right and left-handed thread
- steplessly adjustable via knurled screw
- The chaser is well-guided due to the width of the jaw and does not tilt
- Can be used everywhere regardless of the thread length



M4 - M45

49,00 €

300.0540

DIGITAL BRAKE DISK VERNIER CALLIPER 0 - 60 MM

- In accordance with DIN 862
- For internal measurements
- mm/imperial switching
- Reset (to zero) in every position possible
- Large LCD display - figure height 10.0 mm



47,50 €

*All prices are ex. VAT.

150.2299

HAND BRAKE SHOES RETAINING SPRING TOOL FOR MERCEDES

- Ideal for the assembly and disassembly of the retaining clip on the hand brake jaws of the disk brake
- Guide slots in the function area
- allows easy access to the retention spring laterally behind the hub
- For narrow spaces

Application range: Parking brake retention springs (rear disc brake) for Mercedes V classes Vito and Viano (model 638) 1996 - 2003, (model 639) 2003 - 2014, (model 447) >2014



19,00* €

150.1935

UNIVERSAL HOOK SET, ADAPTABLE

- Universal usage
- adaptable form (flexible)
- these hooks prevent the weight of the brake calliper from damaging the brake hoses
- the fluorescent colour of the signal hose is easily detectable and prevents from leaving the tool on the vehicle
- Shape is maintained and can be altered at any time



9,50* €

104.5065

RATCHET BRAKE LINE CUTTER

- for fast and easy cutting of brake lines
- very good parallel cutting due to the width-accurate cutting is guaranteed
- automatic self-adjustment for faster cutting
- perfectly suitable for confined spaces, also under the vehicle
- Robust ratchet mechanism



29,00* €

150.2237

PNEUMATIC SPINDLE FOR BRAKE PISTON ADAPTOR FOR CONFINED SPACES

- ideal for confined spaces due to optimised counter holding plate
- Ideally suited to damage-free resetting of the brake piston
- The turning direction is set by the user via the angle piece at the end of the spindle
- Comfortable and fast working through pneumatic spindle
- Whilst carrying out maintenance work and when changing the brake pads it is necessary to push the brake pistons back into the brake calliper

INDISPENSABLE FOR THAT BRAKE SERVICING



69,00* €

150.2295

UNIVERSAL BRAKE PISTON RESET TOOL ADAPTER SET

- With individually adjustable 2-pin and 3-pin universal brake piston adapter and 3/8" adapter with magnet
- Ideally suited to damage-free resetting of the brake piston
- No damage to sleeves, pistons or piston holes in the brake calliper
- Whilst carrying out maintenance work and when changing the brake pads it is necessary to push the brake pistons back into the brake calliper
- can be combined with conventional brake piston restorers

SUPER-FLEXIBLE THANKS TO 2-PIN AND 3-PIN UNIVERSAL ADAPTERS



39,00* €

122.1290

FLAREFIX 1 UNIVERSAL BRAKE PIPE FLARING TOOL SET WITH HYDRAULIC SPINDLE

- Easy and handy to use
- Enables use directly on the vehicle
- Prevents damages of the coated surfaces
- For thin walled steel-, Aluminium and copper conductions
- Fast and precise work results through straight flaring tool action

EVERYTHING FOR THE BRAKE LINE



149,00* €

*All prices are ex. VAT.

122.1215

FLAREFIXeco 4.75 MM UNIVERSAL BRAKE PIPE FLARING TOOL SET

- Easy and handy to use
- Enables use directly on the vehicle
- Prevents damages of the coated surfaces
- For the universal use in vehicle workshops
- For thin walled steel-, Aluminium and copper conductions



4 pcs

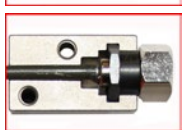

FOR USE STRAIGHT ON THE VEHICLE



49,00* €

160.0710

BLEED NOZZLE ADAPTOR SET FOR BRAKE BLEEDING

- Usable in connection with brake maintenance devices
- Quick and easy to use
- Special seal for brake fluid
- Suitable for >98% of all vehicle types
- Indispensable for all vehicle work shops



4 pcs

BELONGS IN EVERY WORKSHOP

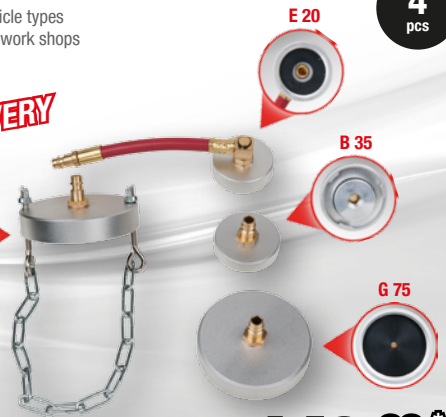
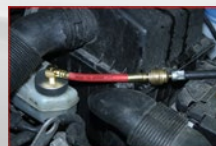

149,00* €

100.5075

WHEEL HUB GRINDER SET Ø 150 MM, INTERNAL Ø 90 MM

- For the optimal cleaning of wheel hubs and brake discs
- ideal for use on large truck, van and large limousine wheel hubs up to Ø 150 mm
- Optimised for the latest wheel hubs with larger inner diameter (Ø 90 mm)
- No flying sparks
- Clean contact surfaces prevent falsification of the wheel tightening torques



2 pcs



49,00* €

160.0725

BRAKE BLEEDING SPANNER SET

- Ideal for hard-to-reach places when bleeding the brakes
- For bleeding the brakes without dismantling of the wheels
- with return valve, which prevents used brake fluid from running back as well as air that has been pumped out
- also suitable for bleeding the coupling system
- extra short 12-point socket



6 pcs



- 11 mm
- 10 mm
- 9 mm
- 8 mm
- 7 mm

79,00* €

150.9524

OIL FILTER WRENCH Ø 74.5 MM / 15 GROOVES

- for quick and professional installation and removal of the hard-to-reach filter cartridge
- Use according to the manufacturer's specification for torque
- Suitable for left and right side operation
- Internal square drive adaptor to DIN 3120 / ISO 1174



Application range: Ford Focus 3, C-Max 2, Galaxy 3, Kuga 2, Mondeo 4, Mondeo 5, S-Max 2, Transit Connect 2 etc. with 1.5 l and 1.6 l EcoBoost petrol engines



Ø 74,5 mm
15 grooves

25,00* €

150.9543

OIL FILTER WRENCH Ø 74.5 MM / 14 GROOVES

- For the quick and professional installation and dismantling of the oil filter cover when changing the oil filter insert
- Use according to the manufacturer's specification for torque
- Suitable for left and right side operation
- Internal square drive adaptor to DIN 3120 / ISO 1174



Application range: Mercedes C-Class (320), CLS (320), E-Class (280, 320), ML (280, 320) etc. with CDI engines (engine code: OM642)

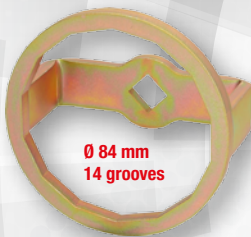

Ø 84 mm
14 grooves

29,00* €

150.9317

OIL FILTER PLIERS

- With PVC dipped handle
- 5-stage industrial adjustment
- Universal usage
- Special tooth profile on the jaws
- Safety stop on the external diameter



50 - 125 mm

290 mm

18,00* €

913.1460

SPIRAL PROFILE IMPACT SOCKET SET

- Internal square drive to DIN 3120 / ISO 1174 with ball reception
- Rejuvenating special profile with aggressive spiral nut
- For turning off of screws with rounded or turned heads
- Bites firmly to give a firm connection between stuck nut and head
- Drive out pin

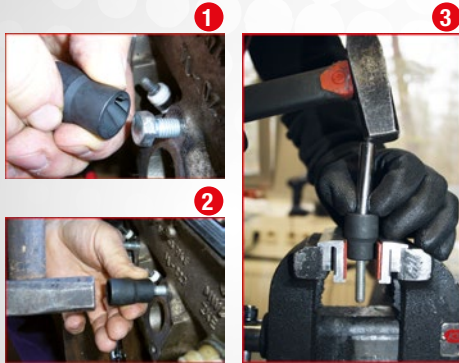

GETS TO GRIPS WITH DAMAGED HEADS



15 pcs

1/4" 1/2"

139,00* €

300.0537

TYRE PROFILE DEPTH GAUGE 0 - 30 MM

- Glare-free reading
- For depth measurements
- Reading 0.1 mm steps for accurate profile depth determination
- Sturdy design
- Made of hard brass



MADE OF HARD BRASS

12,00* €

160.0391-TD

UNIVERSAL RUBBER MAT SET FOR LIFTING PLATFORM

- Perfect underlay to protect sills and paintwork
- Optimal slip resistance
- Universal support for lifting platforms
- Perfect for car body workshops, tyre service lifting platforms etc.
- Very robust and thus versatile



4 pcs

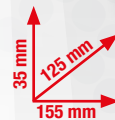
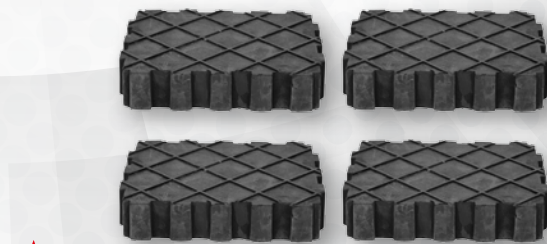

29,00* €

913.1484

WHEEL LOCK DRILL SET

- for quick and simple drilling and removing of the rim locks
- ideal for rim locks with rotating external sleeve
- prevents larger damage on aluminium rims
- including centring sleeves, drill and extractors
- with impact aid and extractor remover

- 2 x Drill, Ø 8,5 mm
- 3 x Centring sleeve, metal, internal Ø 19 - 21 - 24 mm
- 4 x Centring cone, nylon, external Ø 33 - 35 - 37 - 38 mm
- 1 x Packing aid
- 4 x Extractor
- 1 x Extractor remover
- 1 x Release sleeve 17 - 19 mm



16 pcs



PROTECTS YOUR RIMS!

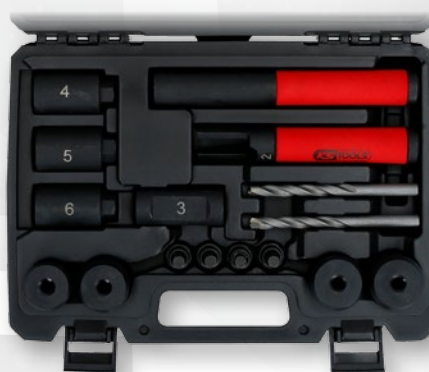

ALSO FOR WHEEL LOCKS WITH ROTATING OUTER SHELL



199,00* €

*All prices are ex. VAT.

150.1070

TYRE VULCANISATION SET FOR CARS

- Simple handling
- Sturdy metal tool
- Ideal for the repair of stitch damage to treads of tubeless tyres
- Contains all tools needed for the repair

Application range: passenger cars, motorcycles, vans, saloon cars

IF THE AIR RUNS OUT

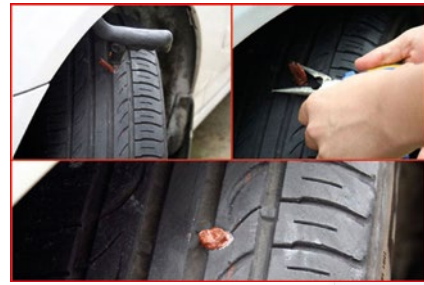

5 pcs



accessories:	
150.1072 Seal repair strips, 100mm, pack of 60	€ 15,00

49,00* €

515.2095

TIRE SERVICE TOOL SET THE DEVIL



6 pcs



1600 Nm

40-200 Nm



*All prices are ex. VAT.



3 pcs

For connoisseurs



CUTLERY SET

11100

15,00*
€



KS TOOLS TOOL BOX FOR CHILDREN

- Toys with realistic function: With this great KS Tools tool set the small craftsman can really get started and is in no way inferior to the professional.
- Skills development: Visual, manual, brain, grasping, intellectual development, sensory perception, hearing, skill training, hand-eye coordination,...
- Extensive range: The children's set includes drill, cordless screwdriver, pliers, hammer, spanner, saw,...
- Realistic design: The battery-operated cordless screwdriver (batteries not included) can be used with two different drills

Age recommendation: 3 to 8 years. Not suitable for children under 36 months. Risk of suffocation due to small parts that can be swallowed.

For junior mechanics



19 pcs



100073

17,50*
€

Your Local Distributor



KS Tools Werkzeuge - Maschinen GmbH

Seligenstädter Grund 10 - 12
D-63150 Heusenstamm

GERMANY

Tel.: +49(0) 61 04 49 74-0

Fax: +49(0) 61 04 49 74-11

e-mail: kstools@kstools.de

www.kstools.com



*This is an limited special price offer - only until stocks last.

All prices are ex. VAT. With the release of this leaflet all previous prices became invalid. Sold only in specialist stores. Print mistakes, errors and technical alterations excepted. Prices valid up to 30.09.2020