



EN

Welding machine

Picotig 200 AC/DC puls 5P TG

Picotig 200 AC/DC puls 8P TG

099-000188-EW501

Observe additional system documents!

10.10.2023

**Register now
and benefit!
Jetzt Registrieren
und Profitieren!**

www.ewm-group.com



General instructions

WARNING



Read the operating instructions!

The operating instructions provide an introduction to the safe use of the products.

- Read and observe the operating instructions for all system components, especially the safety instructions and warning notices!
- Observe the accident prevention regulations and any regional regulations!
- The operating instructions must be kept at the location where the machine is operated.
- Safety and warning labels on the machine indicate any possible risks. Keep these labels clean and legible at all times.
- The machine has been constructed to state-of-the-art standards in line with any applicable regulations and industrial standards. Only trained personnel may operate, service and repair the machine.
- Technical changes due to further development in machine technology may lead to a differing welding behaviour.

In the event of queries on installation, commissioning, operation or special conditions at the installation site, or on usage, please contact your sales partner or our customer service department on +49 2680 181-0.

A list of authorised sales partners can be found at www.ewm-group.com/en/specialist-dealers.

Liability relating to the operation of this equipment is restricted solely to the function of the equipment. No other form of liability, regardless of type, shall be accepted. This exclusion of liability shall be deemed accepted by the user on commissioning the equipment.

The manufacturer is unable to monitor whether or not these instructions or the conditions and methods are observed during installation, operation, usage and maintenance of the equipment.

An incorrectly performed installation can result in material damage and injure persons as a result. For this reason, we do not accept any responsibility or liability for losses, damages or costs arising from incorrect installation, improper operation or incorrect usage and maintenance or any actions connected to this in any way.

© EWM GmbH

Dr. Günter-Henle-Strasse 8

56271 Mündersbach Germany

Tel.: +49 2680 181-0, Fax: -244

Email: info@ewm-group.com

www.ewm-group.com

The copyright to this document remains the property of the manufacturer.

Copying, including extracts, only permitted with written approval.

The content of this document has been prepared and reviewed with all reasonable care. The information provided is subject to change; errors excepted.

Data security

The user is responsible for backing up data of all changes from the factory setting. The user is liable for erased personal settings. The manufacturer does not assume any liability for this.

1 Contents

1	Contents	3
2	For your safety	5
2.1	Notes on using these operating instructions	5
2.2	Explanation of icons	6
2.3	Safety instructions	7
2.4	Transport and installation	10
3	Intended use	12
3.1	Applications	12
3.2	Software version	12
3.3	Documents which also apply	12
3.3.1	Warranty	12
3.3.2	Declaration of Conformity	12
3.3.3	Welding in environments with increased electrical hazards	12
3.3.4	Service documents (spare parts and circuit diagrams)	12
3.3.5	Calibration/Validation	12
3.3.6	Part of the complete documentation	13
4	Machine description – quick overview	14
4.1	Front view / rear view	14
4.2	Machine control – Operating elements	16
4.2.1	Welding data display	17
5	Design and function	18
5.1	Transport and installation	18
5.1.1	Ambient conditions	18
5.1.2	Machine cooling	18
5.1.3	Workpiece lead, general	19
5.1.4	Transport belt	19
5.1.4.1	Adjusting the length of the carrying strap	19
5.1.4.2	Welding torch cooling unit connection	19
5.1.5	Notes on the installation of welding current leads	20
5.1.6	Stray welding currents	22
5.1.7	Mains connection	23
5.1.7.1	Mains configuration	23
5.2	TIG welding	24
5.2.1	Welding torch and workpiece line connection	24
5.2.1.1	Control lead connection	25
5.2.2	Shielding gas supply (shielding gas cylinder for welding machine)	25
5.2.2.1	Connecting the shielding gas supply	25
5.2.3	Welding task selection	26
5.2.4	AC welding	27
5.2.4.1	AC balance (optimise cleaning effect and penetration characteristics)	27
5.2.5	Gas test – setting the shielding gas volume	27
5.2.6	Arc ignition	28
5.2.6.1	HF ignition	28
5.2.6.2	Liftarc	28
5.2.6.3	Automatic cut-out	28
5.2.7	Operating modes (functional sequences)	29
5.2.7.1	Explanation of symbols	29
5.2.7.2	Non-latched mode	30
5.2.7.3	Latched mode	31
5.2.8	Average value pulse welding	32
5.2.9	TIG antistick	32
5.2.10	Welding torch (operating variants)	33
5.2.10.1	Tapping function (tap torch trigger)	33
5.2.10.2	Welding torch mode	33
5.2.10.3	Up/down speed	33
5.2.10.4	Current jump	33
5.2.10.5	Standard TIG torch (5-pole)	34
5.2.10.6	TIG up/down torch (8-pole)	36

5.2.10.7	Potentiometer torch (8-pole)	38
5.2.10.8	Configuring the TIG potentiometer torch connection	39
5.2.10.9	RETOX TIG torch (12-pole)	40
5.2.11	Expert menu (TIG)	41
5.3	MMA welding	42
5.3.1	Connecting the electrode holder and workpiece lead	42
5.3.2	Welding task selection	43
5.3.3	Hotstart	43
5.3.4	Antistick	43
5.3.5	Average value pulse welding	44
5.3.6	Expert menu (MMA)	44
5.4	Voltage reducing device	45
5.5	Remote control	45
5.5.1	RT1 19POL	45
5.5.2	RTG1 19POL	45
5.5.3	RTP1 19POL	45
5.5.4	RTP2 19POL	45
5.5.5	RTP3 spotArc 19POL	46
5.5.6	RTF1 19POL	46
5.5.7	RTF-X TIG 19Pol	46
5.6	Interfaces for automation	46
5.6.1	Remote control connection socket, 19-pole	46
5.7	Access control	47
5.8	Power-saving mode (Standby)	47
5.9	Machine configuration menu	48
5.9.1	Selecting, changing and saving parameters	48
6	Maintenance, care and disposal	51
6.1	General	51
6.1.1	Cleaning	51
6.1.2	Dirt filter	51
6.2	Maintenance work, intervals	52
6.2.1	Daily maintenance tasks	52
6.2.2	Monthly maintenance tasks	52
6.2.3	Annual test (inspection and testing during operation)	52
6.3	Disposing of equipment	53
7	Rectifying faults	54
7.1	Checklist for rectifying faults	54
7.2	Error messages (power source)	56
7.3	Resetting welding parameters to the factory settings	57
7.4	Software version of the machine control	57
8	Technical data	58
8.1	Picotig 200 AC/DC	58
9	Accessories	59
9.1	Welding torch cooling system	59
9.2	Transport system	59
9.3	Remote controls and accessories	59
9.3.1	Connection cables	59
9.4	Option for retrofitting	59
9.5	Option for conversion	60
9.5.1	Machine control Comfort	60
9.6	Shielding gas supply (shielding gas cylinder for welding machine)	60
9.7	General accessories	60
10	Appendix	61
10.1	Parameter overview – setting ranges	61
10.2	Average shielding gas usage	62
10.3	Searching for a dealer	63

2 For your safety

2.1 Notes on using these operating instructions

DANGER

Working or operating procedures which must be closely observed to prevent imminent serious and even fatal injuries.

- Safety notes include the "DANGER" keyword in the heading with a general warning symbol.
- The hazard is also highlighted using a symbol on the edge of the page.

WARNING

Working or operating procedures which must be closely observed to prevent serious and even fatal injuries.

- Safety notes include the "WARNING" keyword in the heading with a general warning symbol.
- The hazard is also highlighted using a symbol in the page margin.

CAUTION

Working or operating procedures which must be closely observed to prevent possible minor personal injury.

- The safety information includes the "CAUTION" keyword in its heading with a general warning symbol.
- The risk is explained using a symbol on the edge of the page.



Technical aspects which the user must observe to avoid material or equipment damage.

Instructions and lists detailing step-by-step actions for given situations can be recognised via bullet points, e.g.:

- Insert the welding current lead socket into the relevant socket and lock.

2.2 Explanation of icons

Symbol	Description	Symbol	Description
	Indicates technical aspects which the user must observe.		Activate and release / Tap / Tip
	Switch off machine		Release
	Switch on machine		Press and hold
	Incorrect / Invalid		Switch
	Correct / Valid		Turn
	Input		Numerical value – adjustable
	Navigation		Signal light lights up in green
	Output		Signal light flashes green
	Time representation (e.g.: wait 4 s / actuate)		Signal light lights up in red
	Interruption in the menu display (other setting options possible)		Signal light flashes red
	Tool not required/do not use		Signal light lights up in blue
	Tool required/use		Signal light flashes blue

2.3 Safety instructions

WARNING



Risk of accidents due to non-compliance with the safety instructions!
Non-compliance with the safety instructions can be fatal!

- Carefully read the safety instructions in this manual!
- Observe the accident prevention regulations and any regional regulations!
- Inform persons in the working area that they must comply with the regulations!



Risk of injury from electrical voltage!

Voltages can cause potentially fatal electric shocks and burns on contact. Even low voltages can cause a shock and lead to accidents.

- Never touch live components such as welding current sockets or stick, tungsten or wire electrodes!
- Always place torches and electrode holders on an insulated surface!
- Wear the full personal protective equipment (depending on the application)!
- The machine may only be opened by qualified personnel!
- The device must not be used to defrost pipes!



Hazard when interconnecting multiple power sources!

If a number of power sources are to be connected in parallel or in series, only a technical specialist may interconnect the sources as per standard IEC 60974-9:2010: Installation and use and German Accident Prevention Regulation BVG D1 (formerly VBG 15) or country-specific regulations.

Before commencing arc welding, a test must verify that the equipment cannot exceed the maximum permitted open circuit voltage.

- Only qualified personnel may connect the machine.
- When taking individual power sources out of operation, all mains and welding current leads must be safely disconnected from the welding system as a whole. (Hazard due to reverse polarity voltage!)
- Do not interconnect welding machines with pole reversing switch (PWS series) or machines for AC welding since a minor error in operation can cause the welding voltages to be combined, which is not permitted.



Risk of injury due to radiation or heat!

Arc radiation can lead to skin and eye injuries.

Contact with hot workpieces and sparks can lead to burns.

- Use hand shield or welding helmet with the appropriate safety level (depends on the application).
- Wear dry protective clothing (e.g. hand shield, gloves, etc.) in accordance with the applicable regulations of your country.
- Persons who are not directly involved should be protected with a welding curtain or suitable safety screen against radiation and the risk of blinding!

WARNING



Risk of injury due to improper clothing!

During arc welding, radiation, heat and voltage are sources of risk that cannot be avoided. The user has to be equipped with the complete personal protective equipment at all times. The protective equipment has to include:

- Respiratory protection against hazardous substances and mixtures (fumes and vapours); otherwise implement suitable measures such as extraction facilities.
- Welding helmet with proper protection against ionizing radiation (IR and UV radiation) and heat.
- Dry welding clothing (shoes, gloves and body protection) to protect against warm environments with conditions comparable to ambient temperatures of 100 °C or higher and arcing and work on live components.
- Hearing protection against harming noise.



Explosion risk!

Apparently harmless substances in closed containers may generate excessive pressure when heated.

- Move containers with inflammable or explosive liquids away from the working area!
- Never heat explosive liquids, dusts or gases by welding or cutting!



Fire hazard!

Due to the high temperatures, sparks, glowing parts and hot slag that occur during welding, there is a risk of flames.

- Be watchful of potential sources of fire in the working area!
- Do not carry any easily inflammable objects, e.g. matches or lighters.
- Ensure suitable fire extinguishers are available in the working area!
- Thoroughly remove any residue of flammable materials from the workpiece prior to starting to weld.
- Only further process workpieces after they have cooled down. Do not allow them to contact any flammable materials!

⚠ CAUTION**Smoke and gases!**

Smoke and gases may lead to shortness of breath and poisoning! The ultraviolet radiation of the arc may also convert solvent vapours (chlorinated hydrocarbon) into poisonous phosgene.

- Ensure sufficient fresh air!
- Keep solvent vapours away from the arc beam field!
- Wear suitable respiratory protection if necessary!
- To prevent the formation of phosgene, residues of chlorinated solvents on workpieces must first be neutralised using appropriate measures.

**Noise exposure!**

Noise exceeding 70 dBA can cause permanent hearing damage!

- Wear suitable ear protection!
- Persons located within the working area must wear suitable ear protection!



According to IEC 60974-10, welding machines are divided into two classes of electromagnetic compatibility (the EMC class can be found in the Technical data) > see 8 chapter:



Class A machines are not intended for use in residential areas where the power supply comes from the low-voltage public mains network. When ensuring the electromagnetic compatibility of class A machines, difficulties can arise in these areas due to interference not only in the supply lines but also in the form of radiated interference.



Class B machines fulfil the EMC requirements in industrial as well as residential areas, including residential areas connected to the low-voltage public mains network.

Setting up and operating

When operating arc welding systems, in some cases, electro-magnetic interference can occur although all of the welding machines comply with the emission limits specified in the standard. The user is responsible for any interference caused by welding.

In order to **evaluate** any possible problems with electromagnetic compatibility in the surrounding area, the user must consider the following: (see also EN 60974-10 Appendix A)

- Mains, control, signal and telecommunication lines
- Radios and televisions
- Computers and other control systems
- Safety equipment
- The health of neighbouring persons, especially if they have a pacemaker or wear a hearing aid
- Calibration and measuring equipment
- The immunity to interference of other equipment in the surrounding area
- The time of day at which the welding work must be carried out

Recommendations for reducing interference emission

- Mains connection, e.g. additional mains filter or shielding with a metal tube
- Maintenance of the arc welding system
- Welding leads should be as short as possible and run closely together along the ground
- Potential equalization
- Earthing of the workpiece. In cases where it is not possible to earth the workpiece directly, it should be connected by means of suitable capacitors.
- Shielding from other equipment in the surrounding area or the entire welding system

**Electromagnetic fields!**

The power source can create electrical or electromagnetic fields that may impair the function of electronic systems such as EDP and CNC devices, telecommunication, power and signal lines as well as pacemakers and defibrillators.



- Follow the maintenance instructions > see 6.2 chapter!
- Unwind the welding leads completely!
- Shield radiation-sensitive equipment or facilities appropriately!
- The function of pacemakers may be impaired (seek medical advice if necessary).

CAUTION



Obligations of the operator!

The respective national directives and laws must be complied with when operating the machine!

- Implementation of national legislation relating to framework directive 89/391/EEC on the introduction of measures to encourage improvements in the safety and health of workers at work and associated individual guidelines.
- In particular, directive 89/655/EEC concerning the minimum safety and health requirements for the use of work equipment by workers at work.
- The regulations applicable to occupational safety and accident prevention in the country concerned.
- Setting up and operating the machine as per IEC 60974.-9.
- Brief the user on safety-conscious work practices on a regular basis.
- Regularly inspect the machine as per IEC 60974.-4.



The manufacturer's warranty becomes void if non-genuine parts are used!

- ***Only use system components and options (power sources, welding torches, electrode holders, remote controls, spare parts and replacement parts, etc.) from our range of products!***
- ***Only insert and lock accessory components into the relevant connection socket when the machine is switched off.***

Requirements for connection to the public mains network

High-performance machines can influence the mains quality by taking current from the mains network. For some types of machines, connection restrictions or requirements relating to the maximum possible line impedance or the necessary minimum supply capacity at the interface with the public network (Point of Common Coupling, PCC) can therefore apply. In this respect, attention is also drawn to the machines' technical data. In this case, it is the responsibility of the operator, where necessary in consultation with the mains network operator, to ensure that the machine can be connected.

2.4 Transport and installation

WARNING



Risk of injury due to improper handling of shielding gas cylinders!

Improper handling and insufficient securing of shielding gas cylinders can cause serious injuries!

- Observe the instructions from the gas manufacturer and any relevant regulations concerning the use of compressed air!
- Do not attach any element to the shielding gas cylinder valve!
- Prevent the shielding gas cylinder from heating up.

⚠ CAUTION**Risk of accidents due to supply lines!**

During transport, attached supply lines (mains leads, control cables, etc.) can cause risks, e.g. by causing connected machines to tip over and injure persons!

- Disconnect all supply lines before transport!

**Risk of tipping!**

There is a risk of the machine tipping over and injuring persons or being damaged itself during movement and set up. Tilt resistance is guaranteed up to an angle of 10° (according to IEC 60974-1).

- Set up and transport the machine on level, solid ground.
- Secure add-on parts using suitable equipment.

**Risk of accidents due to incorrectly installed leads!**

Incorrectly installed leads (mains, control and welding leads or intermediate hose packages) can present a tripping hazard.

- Lay the supply lines flat on the floor (avoid loops).
- Avoid laying the leads on passage ways.

**Risk of injury from heated coolant and its connections!**

The coolant used and its connection or connection points can heat up significantly during operation (water-cooled version). When opening the coolant circuit, escaping coolant may cause scalding.

- Open the coolant circuit only when the power source or cooling unit is switched off!
- Wear proper protective equipment (protective gloves)!
- Seal open connections of the hose leads with suitable plugs.



The units are designed for operation in an upright position!

Operation in non-permissible positions can cause equipment damage.

- ***Only transport and operate in an upright position!***



Accessory components and the power source itself can be damaged by incorrect connection!

- ***Only insert and lock accessory components into the relevant connection socket when the machine is switched off.***
- ***Comprehensive descriptions can be found in the operating instructions for the relevant accessory components.***
- ***Accessory components are detected automatically after the power source is switched on.***



Protective dust caps protect the connection sockets and therefore the machine against dirt and damage.

- ***The protective dust cap must be fitted if there is no accessory component being operated on that connection.***
- ***The cap must be replaced if faulty or if lost!***

3 Intended use

WARNING



Hazards due to improper usage!

The machine has been constructed to the state of the art and any regulations and standards applicable for use in industry and trade. It may only be used for the welding procedures indicated at the rating plate. Hazards may arise for persons, animals and material objects if the equipment is not used correctly. No liability is accepted for any damages arising from improper usage!

- The equipment must only be used in line with its designated purpose and by trained or expert personnel!
- Do not improperly modify or convert the equipment!

3.1 Applications

Arc welding machine for TIG DC and AC welding with lift arc (touch starting) or HF ignition (contactless) and MMA welding as secondary process. It may be possible to expand the functionality by using accessories (see the documentation in the relevant chapter).

3.2 Software version

The software version of the machine control can be displayed in the machine configuration menu (menu *Srv*) > see 5.9 chapter.

3.3 Documents which also apply

3.3.1 Warranty

For more information refer to the "Warranty registration" brochure supplied and our information regarding warranty, maintenance and testing at www.ewm-group.com!

3.3.2 Declaration of Conformity



This product corresponds in its design and construction to the EU directives listed in the declaration. The product comes with a relevant declaration of conformity in the original.

The manufacturer recommends carrying out the safety inspection according to national and international standards and guidelines every 12 months (from commissioning).

3.3.3 Welding in environments with increased electrical hazards



Power sources with this marking can be used for welding in an environment with increased electrical hazard (e.g. boilers). For this purpose, appropriate national or international regulations must be followed. The power source must not be placed in the danger zone!

3.3.4 Service documents (spare parts and circuit diagrams)

WARNING



No improper repairs and modifications!

To prevent injuries and damage to the machine, only competent personnel (authorised service personnel) are allowed to repair or modify the machine.

Unauthorised manipulations will invalidate the warranty!

- Instruct competent personnel (authorised service personnel) to repair the machine.

Original copies of the circuit diagrams are enclosed with the unit.

Spare parts can be obtained from the relevant authorised dealer.

3.3.5 Calibration/Validation

An original certificate is enclosed with the product. The manufacturer recommends calibration / validation at intervals of 12 months (from commissioning).

3.3.6 Part of the complete documentation

This document is part of the complete documentation and valid only in combination with all other parts of these instructions! Read and observe the operating instructions for all system components, especially the safety instructions!

The illustration shows a general example of a welding system.

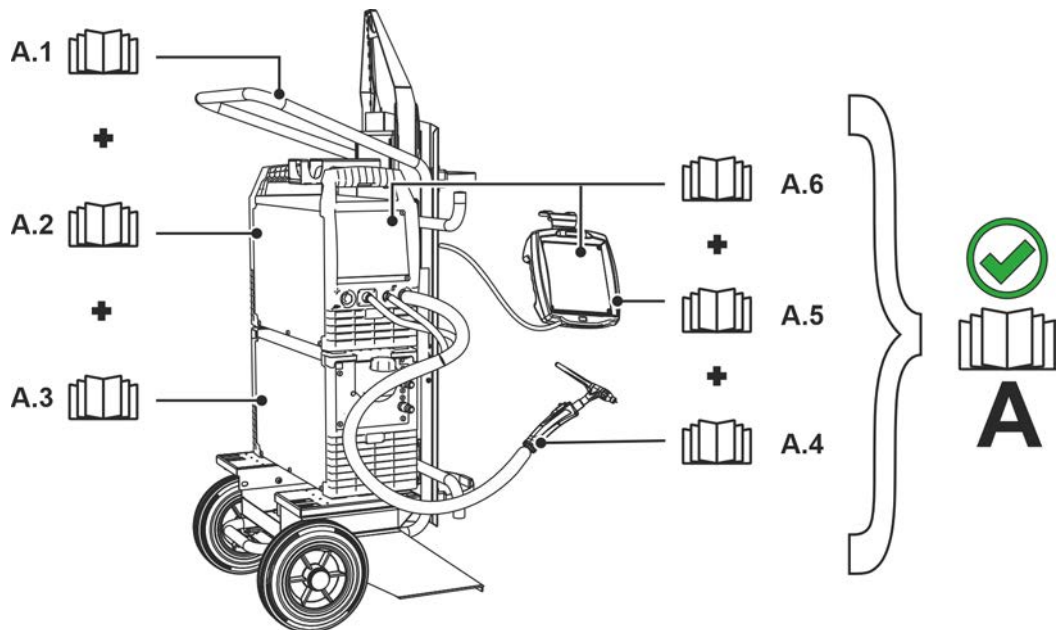

Figure 3-1

Item	Documentation
A.1	Transport vehicle
A.2	Power source
A.3	Cooling unit
A.4	Welding torch
A.5	Remote control
A.6	Control
A	Complete documentation

4 Machine description – quick overview

4.1 Front view / rear view

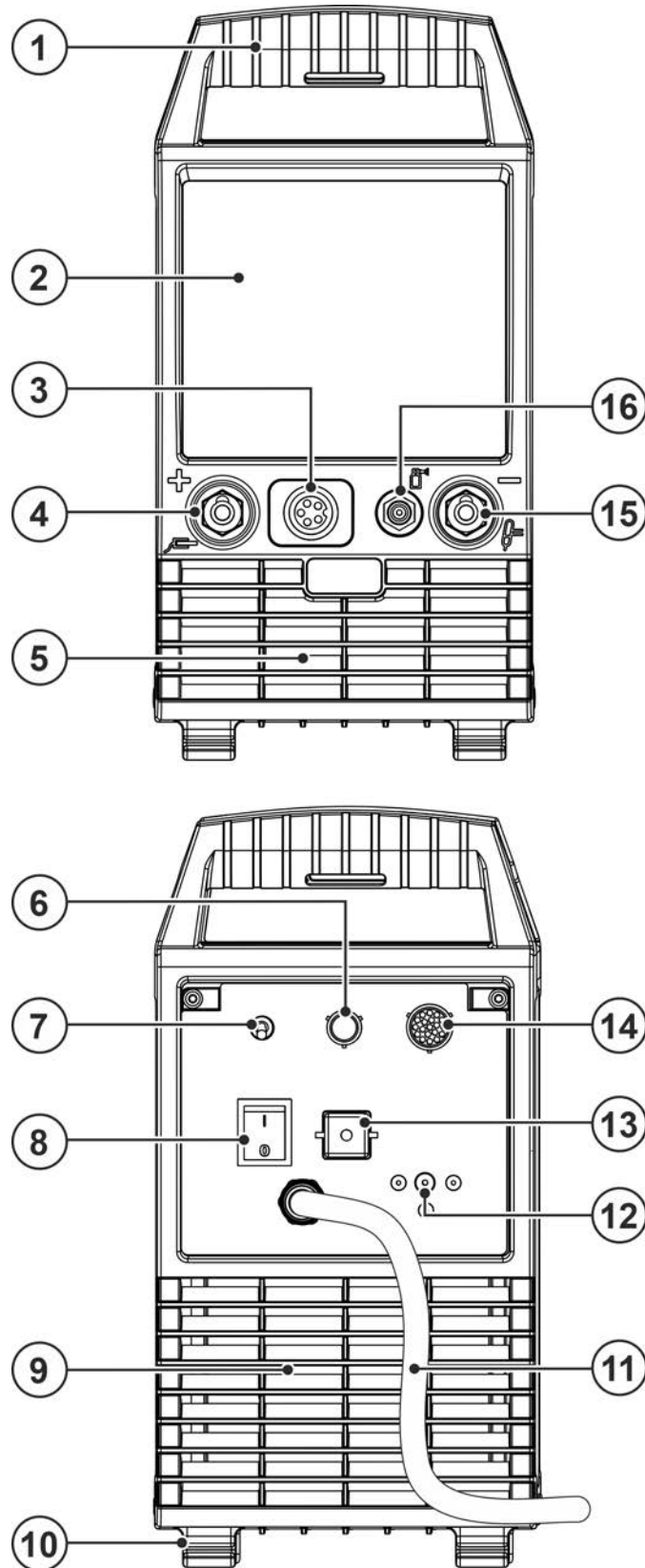











Figure 4-1

Item	Symbol	Description
1		Transport elements Transport handle and transport belt > see 5.1.4 chapter
2		Machine control > see 4.2 chapter
3		Connection socket (welding torch control cable) > see 5.2.1.1 chapter
4		Connection socket, “+” welding current How to connect the accessories depends on the welding procedure. Please observe the connection description for the corresponding welding procedure > see 5 chapter.
5		Cooling air inlet
6		8-pole connection socket Cooling unit control lead
7		Ignition type changeover switch > see 5.2.6 chapter ⌘ = -----Liftarc (contact ignition) HF = -----HF ignition
8		Main Switch Switching the machine on or off.
9		Cooling air outlet
10		Machine feet
11		Mains connection cable > see 5.1.7 chapter
12		Connection thread - G$\frac{1}{4}$" Shielding gas connection (inlet)
13		4-pole connection socket Cooling unit voltage supply
14		Connection socket, 19-pole Remote control connection
15		Connection socket, “-” welding current How to connect the accessories depends on the welding procedure. Please observe the connection description for the corresponding welding procedure > see 5 chapter.
16		Connection thread - G$\frac{1}{4}$" Shielding gas connection (outlet)

4.2 Machine control – Operating elements

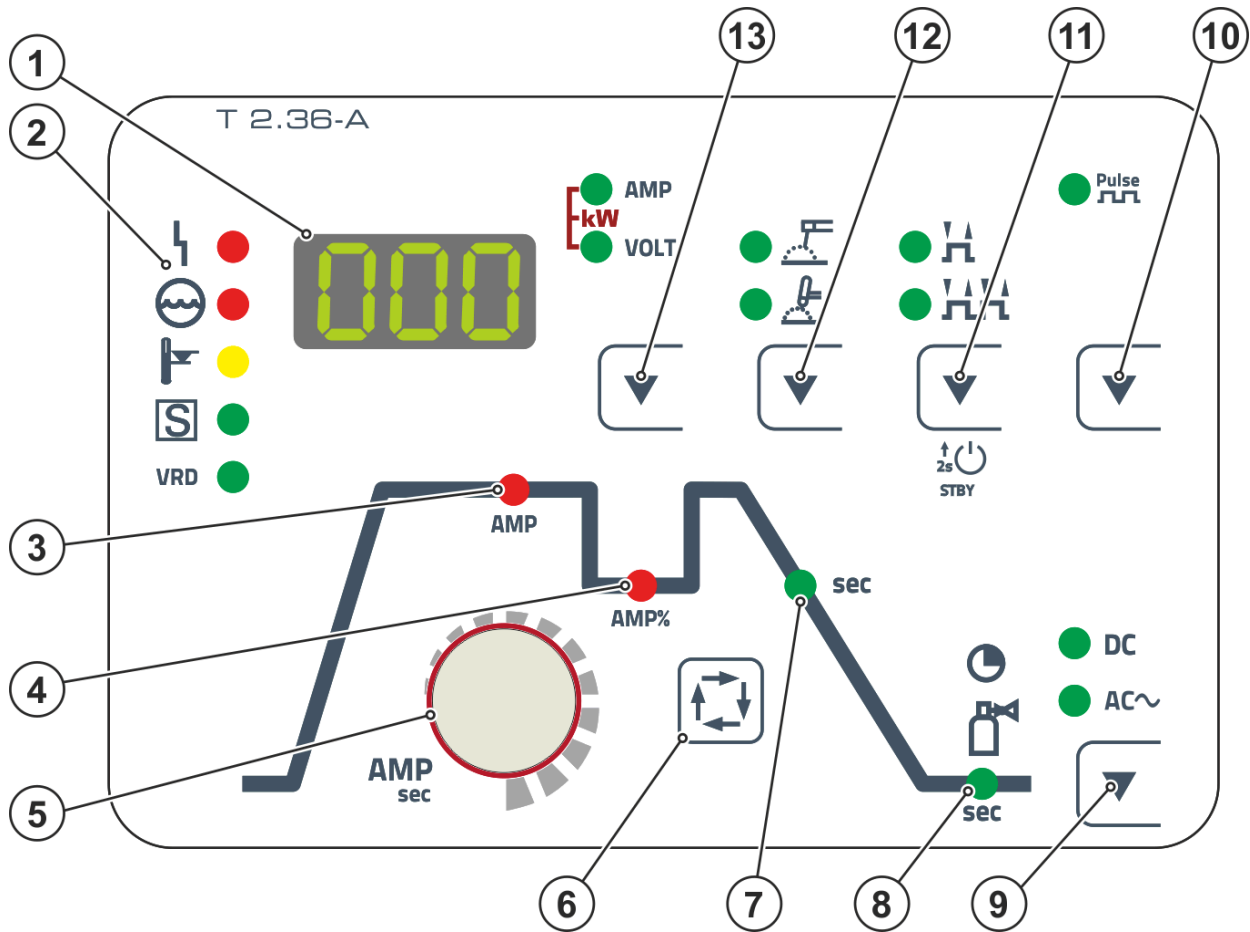









Figure 4-2

Item	Symbol	Description
1		Welding data display (3-digit) Displays the welding parameters and the corresponding values > see 4.2.1 chapter
2		Error/status displays <ul style="list-style-type: none"> ----- Collective interference signal light ----- Water deficiency signal light (welding torch cooling) ----- Excess temperature signal light ----- S sign signal light VRD ----- voltage reduction device (VRD) > see 5.4 chapter
3	AMP	Main current signal light I _{min} to I _{max} (1 A increments)
4	AMP%	Secondary current (TIG)
5		Welding parameter setting rotary dial Setting currents, times and parameters.
6		Select welding parameters button This button is used to select the welding parameters depending on the welding process and operating mode used.
7	sec	Down-slope time (TIG)
8		Signal light, gas post-flow time
9		Welding current polarity push-button DC ----- DC welding with negative polarity at the torch (or electrode holder) with respect to the workpiece. AC ~ -- Alternating current welding/alternating current forms > see 5.2.4 chapter

Item	Symbol	Description
10		Pulsed welding push-button TIG -----pulsed welding > see 5.2.8 chapter MMA -----pulsed welding > see 5.3.5 chapter
11		Operating mode/power-saving mode push-button  -----Non-latched  -----Latched Press for 2 s to put the machine into power-saving mode. To reactivate, activate one of the operating elements > see 5.8 chapter.
12		Welding procedure push-button  -----MMA welding  -----TIG welding
13		Display switching push-button AMP -----Welding current display kW-----Welding performance display (both signal lights are illuminated) VOLT ----Welding voltage display

4.2.1 Welding data display

The following welding parameters can be displayed before (nominal values), during (actual values) or after welding (hold values):

Parameter	Nominal values	Actual values	Hold values
Welding current	<input checked="" type="checkbox"/>	<input checked="" type="checkbox"/>	<input type="checkbox"/>
Welding voltage	<input type="checkbox"/>	<input checked="" type="checkbox"/>	<input checked="" type="checkbox"/>
Welding power	<input type="checkbox"/>	<input checked="" type="checkbox"/>	<input checked="" type="checkbox"/>

When the hold values are displayed after welding and the settings are then changed (e.g. welding current), the display will switch to the relevant nominal values.

not possible

possible

5 Design and function

WARNING



Risk of injury from electrical voltage!

Contact with live parts, e.g. power connections, can be fatal!

- Observe the safety information on the first pages of the operating instructions!
- Commissioning must be carried out by persons who are specifically trained in handling power sources!
- Connect connection or power cables while the machine is switched off!

Read and observe the documentation to all system and accessory components!

5.1 Transport and installation

WARNING



Risk of accident due to improper transport of machines that must not be lifted!

Do not lift or suspend the machine! The machine can drop and cause injuries! The handles, straps or brackets are suitable for transport by hand only!

- The machine must not be suspended or lifted using a crane.



Damage to the machine due to improper transport!

The machine can be damaged by tensile or lateral forces if it is set down or picked up in a non-vertical position!

- **Do not drag the machine horizontally on the machine feet!**
- **Always pick up the machine vertically and set it down carefully.**

5.1.1 Ambient conditions



The machine must not be operated in the open air and must only be set up and operated on a suitable, stable and level base!

- **The operator must ensure that the ground is non-slip and level, and provide sufficient lighting for the place of work.**
- **Safe operation of the machine must be guaranteed at all times.**



Equipment damage due to contamination!

Unusually high amounts of dust, acids, corrosive gases or substances can damage the machine (observe maintenance intervals > see 6.2 chapter).

- **Avoid large amounts of smoke, steam, oily fumes, grinding dust and corrosive ambient air!**

In operation

Temperature range of the ambient air:

- -25 °C to +40 °C (-13 °F to 104 °F)

Relative humidity:

- up to 50 % at 40 °C (104 °F)
- up to 90 % at 20 °C (68 °F)

Transport and storage

Storage in a closed room, temperature range of the ambient air:

- -30 °C to +70 °C (-22 °F to 158 °F)

Relative humidity

- up to 90 % at 20 °C (68 °F)

5.1.2 Machine cooling



Insufficient ventilation results in a reduction in performance and equipment damage.

- **Observe the ambient conditions!**
- **Keep the cooling air inlet and outlet clear!**
- **Observe the minimum distance of 0.5 m from obstacles!**

5.1.3 Workpiece lead, general

⚠ CAUTION



Risk of burning due to incorrect welding current connection!

If the welding current plugs (machine connections) are not locked or if the workpiece connection is contaminated (paint, corrosion), these connections and leads can heat up and cause burns when touched!

- Check welding current connections on a daily basis and lock by turning to the right when necessary.
- Clean workpiece connection thoroughly and secure properly. Do not use structural parts of the workpiece as welding current return lead!

5.1.4 Transport belt

5.1.4.1 Adjusting the length of the carrying strap

To demonstrate adjustment, lengthening the strap is shown in the figure. To shorten, the strap's loops must be inched in the opposite direction.

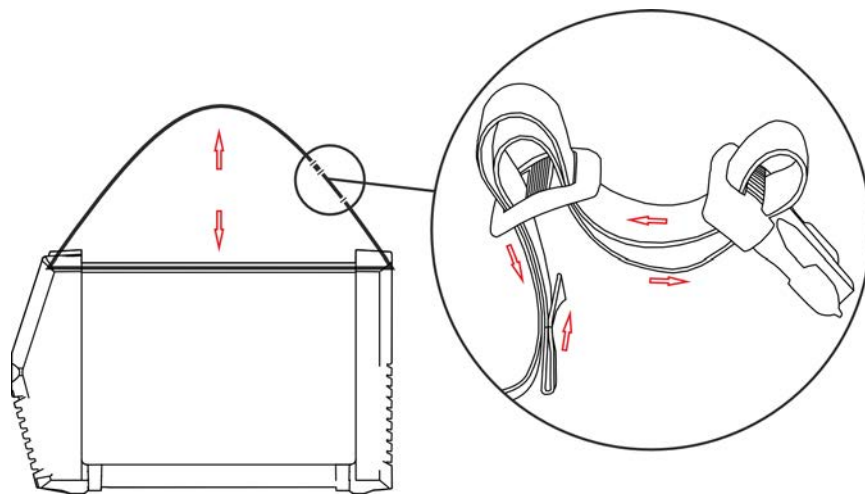

Figure 5-1

5.1.4.2 Welding torch cooling unit connection

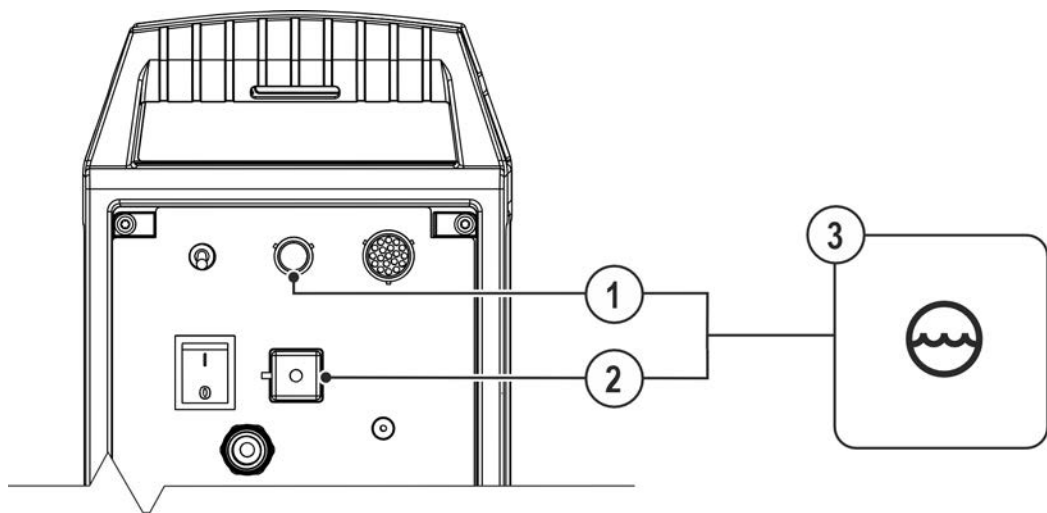

Figure 5-2

Item	Symbol	Description
1		8-pole connection socket Cooling unit control lead
2		5-pole connection socket Cooling unit voltage supply

Item	Symbol	Description
3		Cooling module

- Insert and lock the 8-pole control lead plug on the cooling unit into the 8-pole connection socket on the welding machine.
- Insert and lock the 5-pole supply plug on the cooling unit into the 5-pole connection socket on the welding machine.

5.1.5 Notes on the installation of welding current leads

- Incorrectly installed welding current leads can cause faults in the arc (flickering).
- Lay the workpiece lead and hose package of power sources without HF igniter (MIG/MAG) for as long and as close as possible in parallel.
- Lay the workpiece lead and hose package of power sources with HF igniter (TIG) for as long as possible in parallel with a distance of 20 cm to avoid HF sparkover.
- Always keep a distance of at least 20 cm to leads of other power sources to avoid interferences
- Always keep leads as short as possible! For optimum welding results max. 30 m (welding lead + intermediate hose package + torch lead).

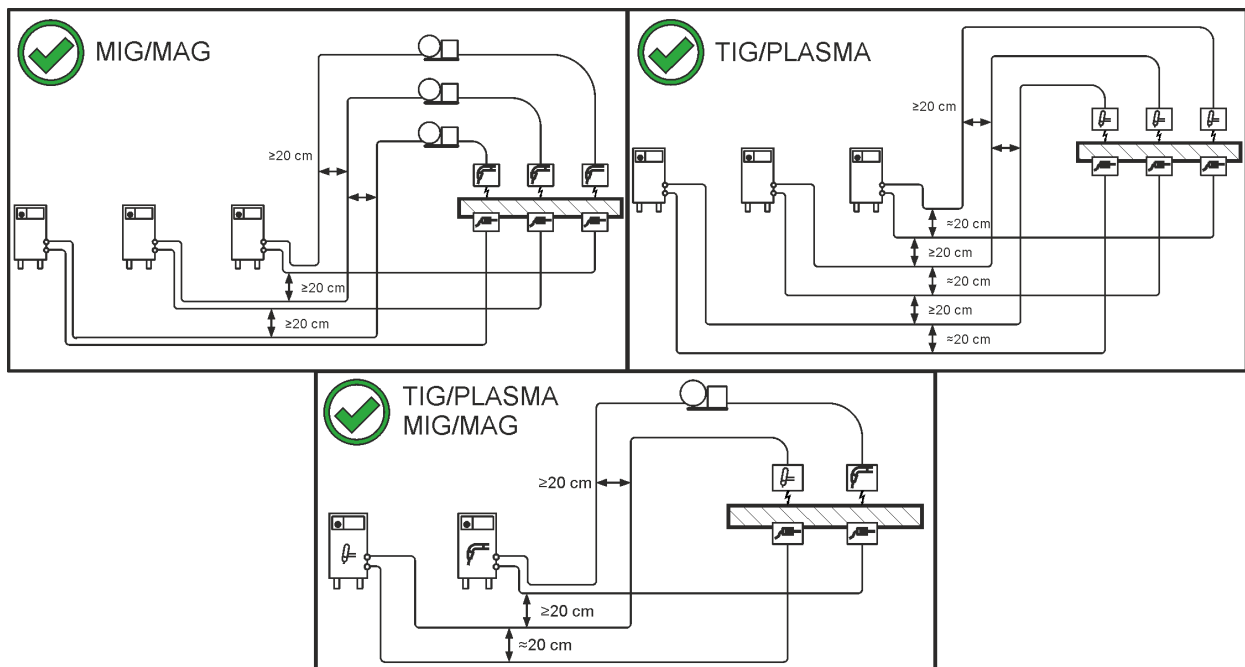

Figure 5-3

- Use an individual welding lead to the workpiece for each welding machine!

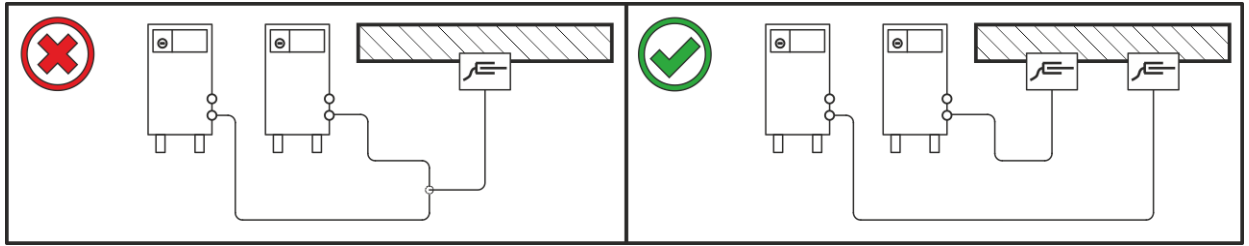

Figure 5-4

- Fully unroll welding current leads, torch hose packages and intermediate hose packages. Avoid loops!
- Always keep leads as short as possible!

Lay any excess cable lengths in meanders.

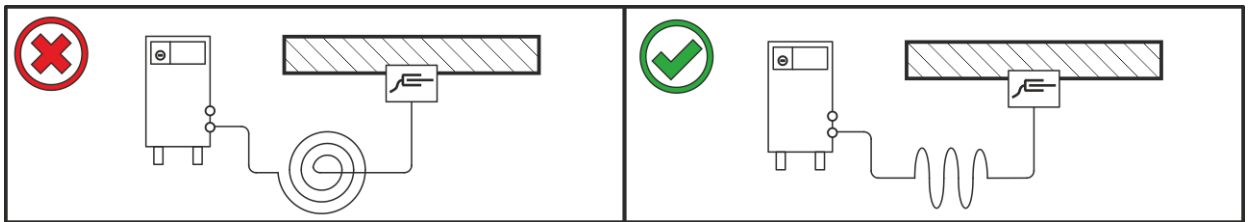

Figure 5-5

5.1.6 Stray welding currents

⚠ WARNING



Risk of injury due to stray welding currents!

Stray welding currents can destroy protective earth conductors, damage machines and electronic devices and cause overheating of components, leading to fire.

- Check that all welding current connections are firmly secured and electrical connections are in perfect condition.
- Set up, attach or suspend all conductive power source components such as casing, transport vehicles and crane frames so they are insulated.
- Do not place any other electronic devices such as drills or angle grinders on the power source, transport vehicle or crane frames unless they are insulated.
- Always put welding torches and electrode holders on an insulated surface when they are not in use.

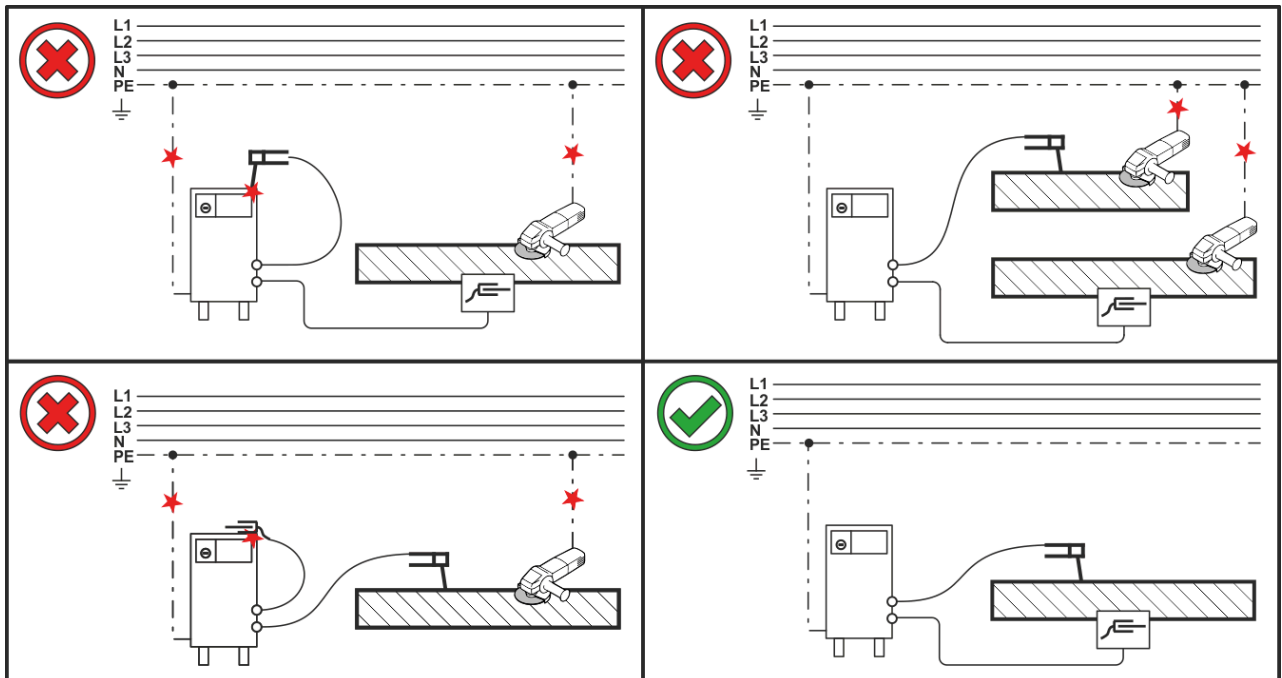

Figure 5-6

5.1.7 Mains connection

DANGER



Hazards caused by improper mains connection!

An improper mains connection can cause injuries or damage property!

- The connection (mains plug or cable), the repair or voltage adjustment of the device must be carried out by a qualified electrician in accordance with the respective local laws or national regulations!
- The mains voltage indicated on the rating plate must match the supply voltage.
- Only operate machine using a socket that has correctly fitted protective earth.
- Mains plug, socket and lead must be checked by a qualified electrician on a regular basis!
- When operating the generator, always ensure it is earthed as stipulated in the operating instructions. The network created must be suitable for operating machines according to protection class I.

5.1.7.1 Mains configuration



The machine may only be connected to a one-phase system with two conductors and an earthed neutral conductor.

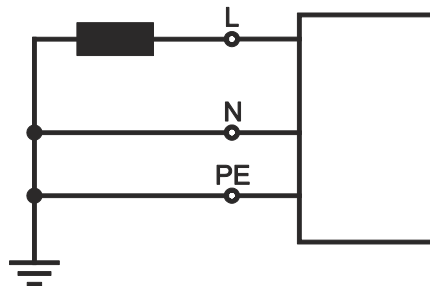

Figure 5-7

Legend

Item	Designation	Colour code
L	Outer conductor	brown
N	Neutral conductor	blue
PE	Protective conductor	green-yellow

- Insert mains plug of the switched-off machine into the appropriate socket.

5.2 TIG welding

5.2.1 Welding torch and workpiece line connection

Prepare welding torch according to the welding task in hand (see operating instructions for the torch).

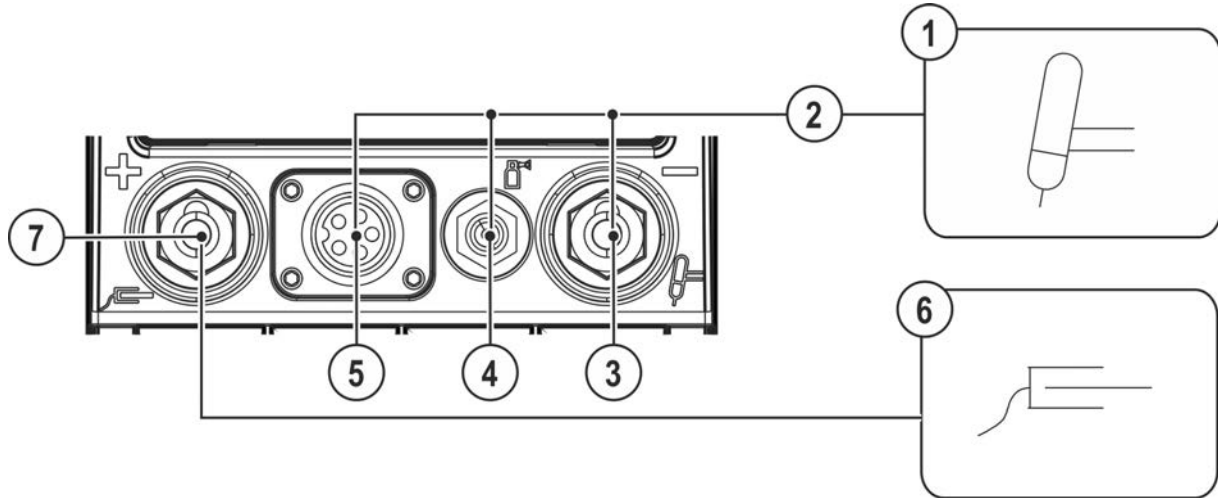

Figure 5-8

Item	Symbol	Description
1		Welding torch
2		Welding torch hose package
3		Connection socket, "-" welding current Welding current lead connection for TIG welding torch
4		Connection thread - G$\frac{1}{4}$" Shielding gas connection (outlet)
5		Connection socket (welding torch control cable) > see 5.2.1.1 chapter
6		Workpiece
7		Connection socket for "+" welding current Workpiece lead connection

- Insert the welding current plug on the welding torch into the welding current connection socket and lock by turning to the right.
- Remove yellow protective cap on G $\frac{1}{4}$ " connecting nipple.
- Screw welding torch shielding gas connection tightly onto the G $\frac{1}{4}$ " connection nipple.
- Plug the welding torch control cable plug into the welding torch control cable connection socket and secure.
- Insert the cable plug on the work piece lead into the "+" welding current connection socket and lock by turning to the right.

5.2.1.1 Control lead connection

TIG welding machines are equipped ex works with a dedicated connection socket for the welding torch control cable (5- or 8-pole). As mobile machines offer more free space, they may even feature two control cable connection sockets. The functionality increases with the number of poles. One of these connection sockets may be converted or retrofitted > see 9 chapter.

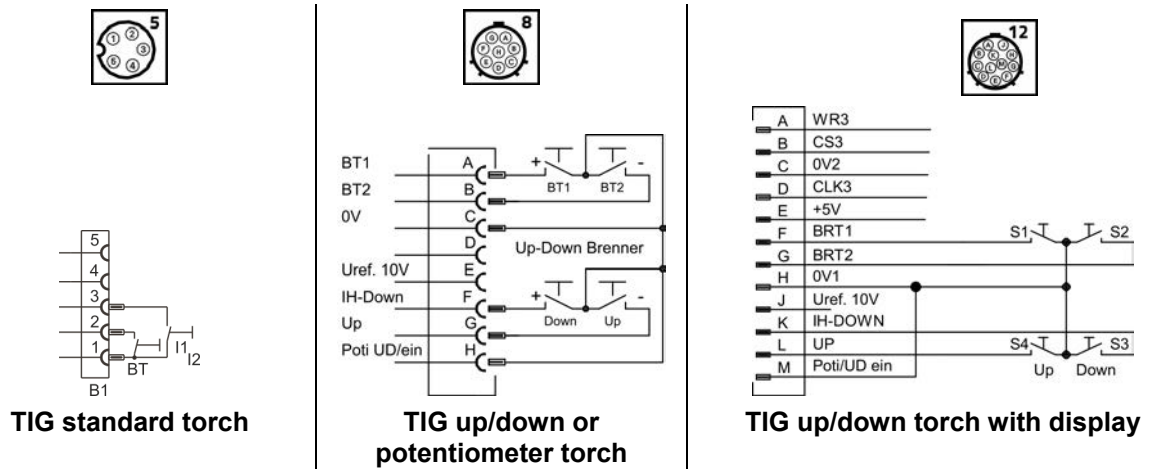

Figure 5-9

5.2.2 Shielding gas supply (shielding gas cylinder for welding machine)

⚠ WARNING



Risk of injury due to improper handling of shielding gas cylinders! Improper handling and insufficient securing of shielding gas cylinders can cause serious injuries!

- Place shielding gas cylinder into the designated holder and secure with fastening elements (chain/belt)!
- Attach the fastening elements within the upper half of the shielding gas cylinder!
- The fastening elements must tightly enclose the shielding gas cylinder!

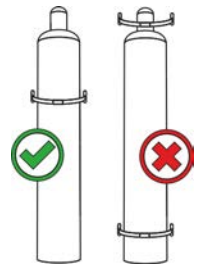

An unhindered shielding gas supply from the shielding gas cylinder to the welding torch is a fundamental requirement for optimum welding results. In addition, a blocked shielding gas supply may result in the welding torch being destroyed.

- Always re-fit the yellow protective cap when not using the shielding gas connection.
- All shielding gas connections must be gas tight.

5.2.2.1 Connecting the shielding gas supply

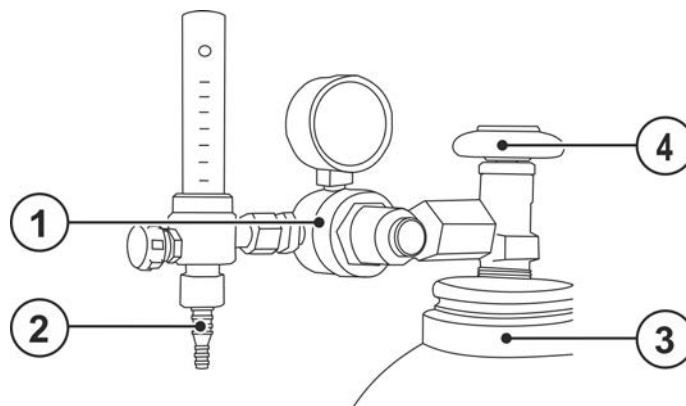

Figure 5-10

Item	Symbol	Description
1		Pressure regulator
2		Output side of the pressure regulator

Item	Symbol	Description
3		Shielding gas cylinder
4		Cylinder valve

- Before connecting the pressure regulator to the gas cylinder, open the cylinder valve briefly to blow out any dirt.
- Tighten the pressure regulator screw connection on the gas bottle valve to be gas-tight.
- Screw the gas hose connection to the outlet side of the pressure regulator gas-tight.
- Install gas hose with G1/4" crown nut at the correct welding machine connection $\bar{\square}$ so that it is gas-tight.

5.2.3 Welding task selection

The following welding task selection is an example of use. In general, the selection process always has the same sequence. Signal lights (LED) will show the selected combination.

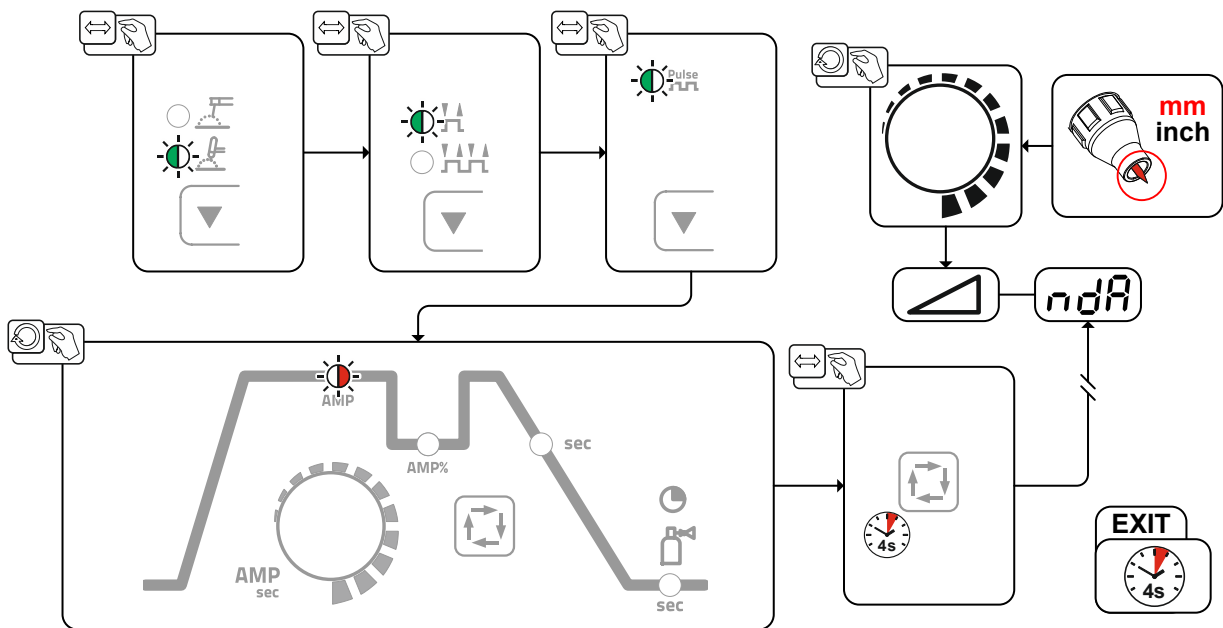

Figure 5-11

5.2.4 AC welding

5.2.4.1 AC balance (optimise cleaning effect and penetration characteristics)

It is important to choose the right time relationship (balance) between the positive phase (cleaning effect, beaded end size) and the negative phase (penetration depth). This may differ from the factory setting depending on the material and task. This requires the AC balance setting. The default setting (factory setting, zero setting) of the balance is 65 % and always refers to the negative half-wave. The positive half-wave is adjusted accordingly (negative half-wave = 65 %, positive half-wave = 35 %).

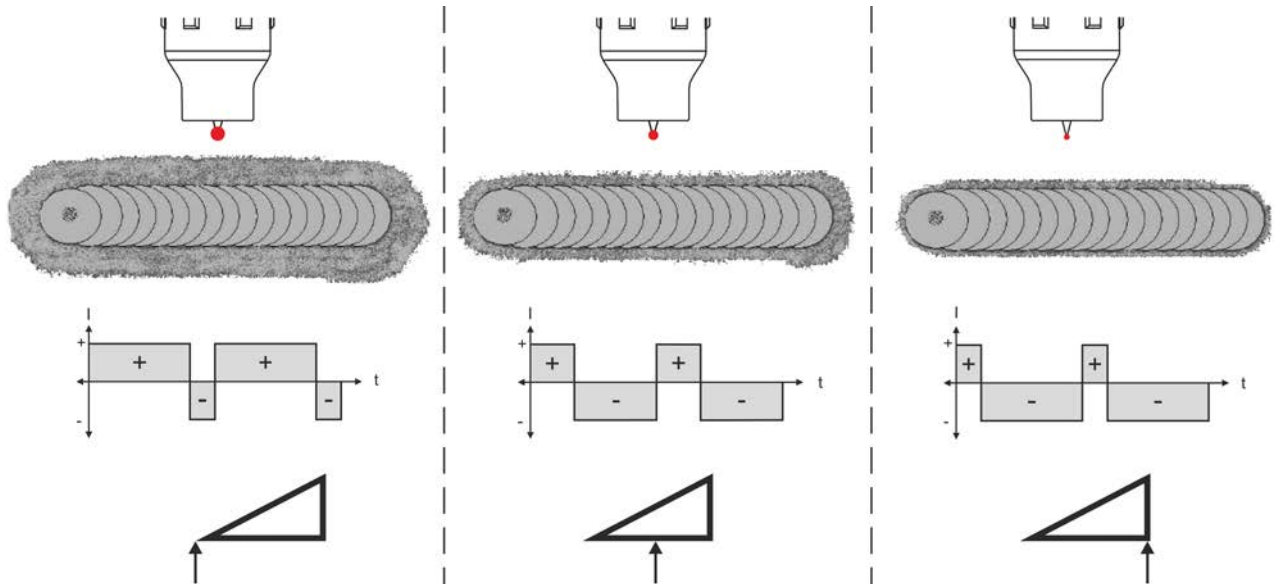

Figure 5-12

5.2.5 Gas test – setting the shielding gas volume

⚠ CAUTION



Electric shocks!

When setting the shielding gas quantity, high voltage ignition pulses or open circuit voltage are applied at the welding torch; these can lead to electric shocks and burning on contact.

- Keep the welding torch electrically insulated from persons, animals or equipment during the setting procedure.

If the shielding gas setting is too low or too high, this can introduce air to the weld pool and may cause pores to form. Adjust the shielding gas quantity to suit the welding task!

Rule of thumb for the gas flow rate:

Diameter of gas nozzle in mm corresponds to gas flow in l/min.

Example: 7mm gas nozzle corresponds to 7l/min gas flow.

- Press the torch trigger and set the shielding gas quantity with the flow gauge of the pressure regulator.

5.2.6 Arc ignition

The ignition type can be set at the ignition type changeover switch > see 4.1 chapter.

5.2.6.1 HF ignition

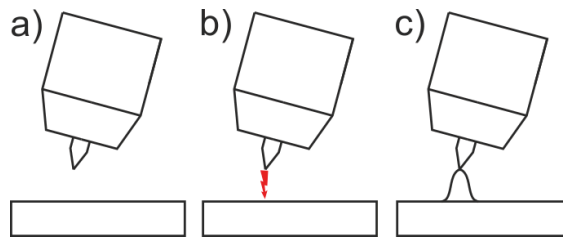

Figure 5-13

The arc is started without contact using high-voltage ignition pulses:

- Position the welding torch in the welding position above the workpiece (distance between the electrode tip and the workpiece approx. 2-3 mm).
- Press the torch trigger (high-voltage ignition pulses start the arc).
- Depending on the selected operating mode, the welding current flows with the set start or main current.

Ending the welding process: Release the torch trigger or press and release depending on the selected operating mode.

5.2.6.2 Liftarc

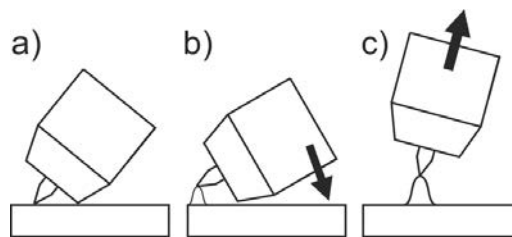

Figure 5-14

The arc is ignited on contact with the workpiece:

- Carefully place the torch gas nozzle and tungsten electrode tip onto the workpiece and press the torch trigger (liftarc current flowing, regardless of the main current set).
- Incline the torch over the torch gas nozzle to produce a gap of approx. 2-3 mm between the electrode tip and the workpiece. The arc ignites and the welding current is increased, depending on the operating mode set, to the ignition or main current set.
- Lift off the torch and swivel to the normal position.

Ending the welding process: Release or press the torch trigger depending on the operating mode selected.

5.2.6.3 Automatic cut-out

Once the fault periods have elapsed, the automatic cut-out stops the welding process when it has been triggered by one of two states:

- During ignition
3 s after the start of the welding process, no welding current flows (ignition error).
- During welding
The arc is interrupted for more than 3 s (arc interruption).

5.2.7 Operating modes (functional sequences)

Using the welding parameter push-button and welding parameter setting rotary knob the sequence parameters are set.

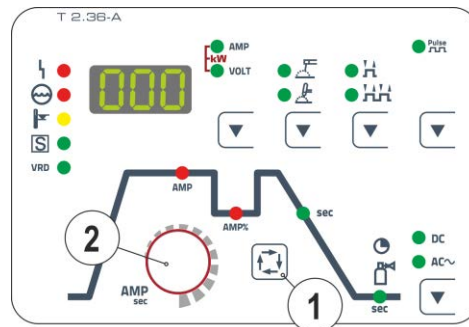

Figure 5-15

Item	Symbol	Description
1		Select welding parameters button This button is used to select the welding parameters depending on the welding process and operating mode used.
2		Welding parameter setting rotary dial Setting currents, times and parameters.

5.2.7.1 Explanation of symbols

Symbol	Meaning
	Press torch trigger 1
	Release torch trigger 1
I	Current
t	Time
	Gas pre-flows
Istart	Start current
tUp	Up-slope time
tP	Spot time
AMP	Main current (minimum to maximum current)
AMP%	Secondary current (0% to 100% of AMP)
tDown	Down-slope time
Iend	End-crater current
	Gas post-flows

5.2.7.2 Non-latched mode

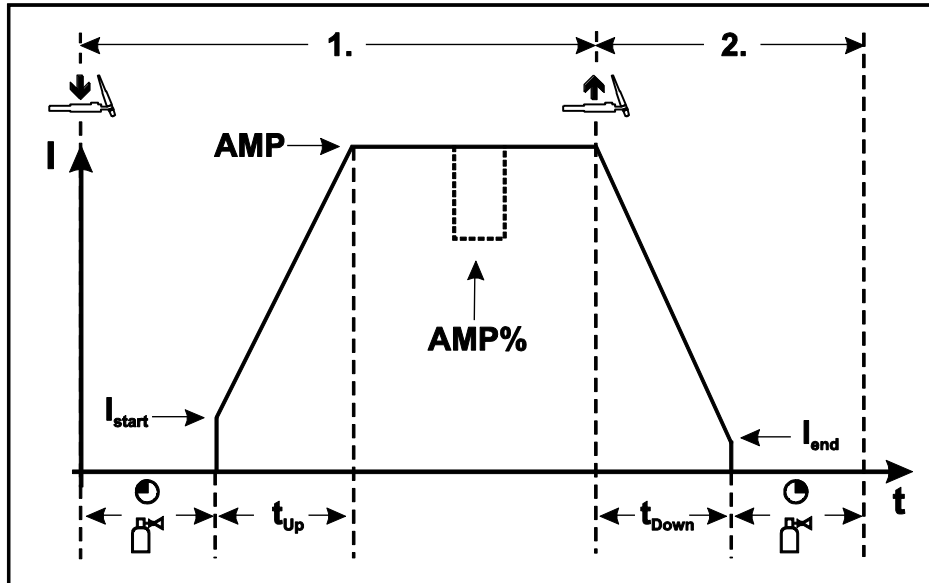

Figure 5-16

1st cycle:

- Press and hold torch trigger 1.
- The gas pre-flow time elapses.
- HF ignition pulses jump from the electrode to the workpiece, the arc ignites.
- The welding current flows and immediately assumes the value set for the start current I_{start} .
- HF is switched off.
- The welding current increases with the adjusted up-slope time to the main current AMP.

Switching from main current AMP to secondary current AMP%:

Press torch trigger 2 or Tap torch trigger 1

2nd cycle:

- Release torch trigger 1.
- The main current falls in the set down-slope time to the end-crater current I_{end} (minimum current).

If the 1st torch trigger is pressed during the down-slope time, the welding current returns to the main current AMP set.

- The main current reaches the end-crater current I_{end} , the arc extinguishes.
- The set gas post-flow time elapses.

When the foot-operated remote control is connected, the machine switches automatically to non-latched operation. The up- and down-slopes are switched off.

5.2.7.3 Latched mode

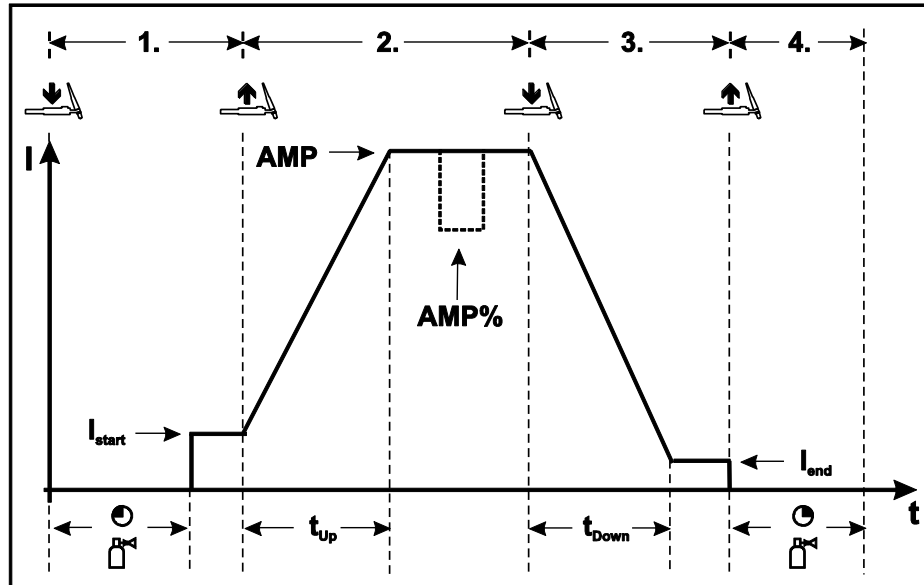

Figure 5-17

Step 1

- Press torch trigger 1, the gas pre-flow time elapses.
- HF ignition pulses jump from the electrode to the workpiece, the arc ignites.
- Welding current flows and immediately assumes the start current value set (search arc at minimum setting). HF is switched off.

Step 2

- Release torch trigger 1.
- The welding current increases with the set up-slope time to the main current AMP.

Switching from main current AMP to secondary current AMP%:

Press torch trigger 2 or Tap torch trigger 1

Step 3

- Press torch trigger 1.
- The main current drops with the set down-slope time to the end-crater current I_{end} (minimum current).

Step 4

- Release torch trigger 1, the arc extinguishes.
- The set gas post-flow time begins.

Immediate termination of the welding process in the downslope by releasing torch trigger 1.

When the foot-operated remote control is connected, the machine switches automatically to non-latched operation. The up- and down-slopes are switched off.

A double-digit torch mode (11 x) needs to be set at the welding machine control to use the alternative welding start (tapping start). The number of torch modes available depends on the machine type.

5.2.8 Average value pulse welding

Once the function is activated, the red signal lights for the main current AMP and secondary current AMP% light up at the same time.

Average value pulse welding means that the system switches between two currents periodically, an average current value (AMP), a pulse current (I_{puls}), a balance (bRL) and a frequency (FRE) having been defined first. The predefined ampere current average value is decisive, the pulse current (I_{puls}) is defined by the iPL parameter as a percentage of the average current value (AMP).

The pulse pause current (IPP) is not set; the machine control calculates the value instead to ensure that the average value of the welding current (AMP) is maintained. For average value pulsing, the $i2$ current is the secondary current only, activated with the torch trigger.

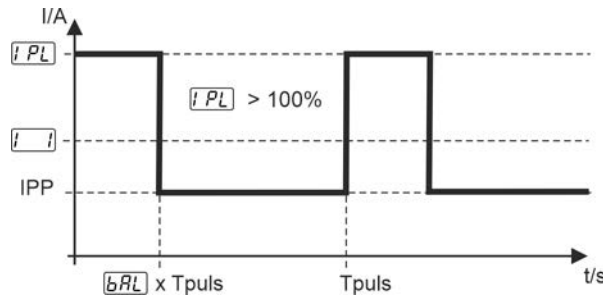

Figure 5-18

AMP = main current (average value), e.g. 100 A

I_{puls} = pulse current = $iPL \times AMP$, e.g. 140% \times 100 A = 140 A

IPP = pulse pause current

T_{puls} = duration of one pulse cycle = $1/FRE$, e.g. 1/100 Hz = 10 ms

bRL = balance

Selection

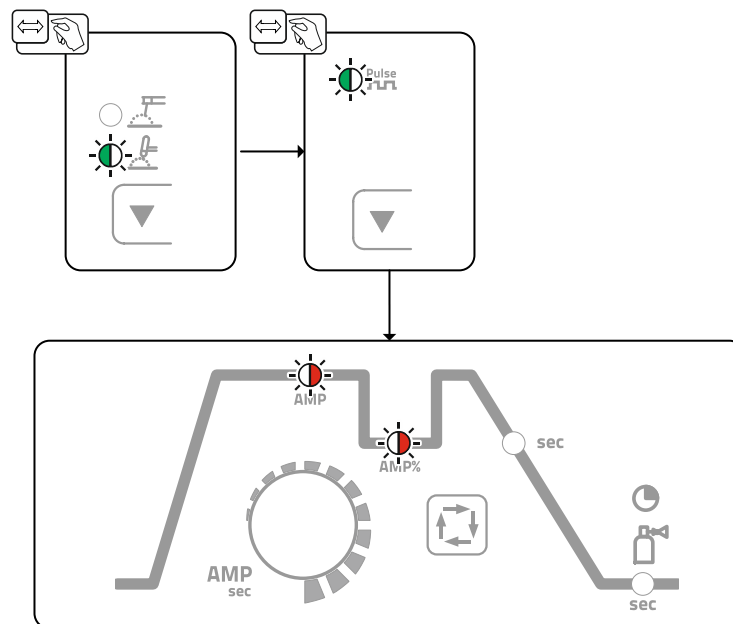

Figure 5-19

5.2.9 TIG antistick

The function prevents uncontrolled re-ignition following the sticking of the tungsten electrode in the weld pool by switching off the welding current. In addition, wear at the tungsten electrode is reduced.

After triggering the function the machine immediately switches to the gas post-flow process phase. The welder starts the new process again at the first cycle. The user can switch the function on or off (parameter iRS) > see 5.9 chapter.

5.2.10 Welding torch (operating variants)

Different torch versions can be used with this machine.

Functions on the operating elements, such as torch triggers (BRT), rockers or potentiometers, can be modified individually via torch modes.

Explanation of symbols for operating elements:

Symbol	Description
	Press torch trigger
	Tap torch trigger
	Tap and press torch trigger

5.2.10.1 Tapping function (tap torch trigger)

Tapping function: Swiftly tap the torch trigger to change the function. The set torch mode determines the operating mode.

5.2.10.2 Welding torch mode

Modes 1 to 4 and 11 to 14 are available to the user. Modes 11 to 14 feature the same functionality as 1 to 4, but without the tapping function > see 5.2.10.1 chapter for the secondary current.

The functionality of the individual modes can be found in the corresponding torch type tables.

The torch modes are set using the torch configuration parameters "Er d" in the machine configuration menu > torch mode "b i" > see 5.9 chapter.

Only the modes listed are suitable for the corresponding torch types.

5.2.10.3 Up/down speed

Functionality

Press and hold the up push-button:

Increase current up to the maximum value (main current) set in the power source.

Press and hold the down push-button:

Decrease current to the minimum value.

Use the machine configuration menu > see 5.9 chapter to set the up/down speed parameter u 5 which determines the speed with which a current change becomes effective.

5.2.10.4 Current jump

This function is only available when using up/down torches in modes 4 and 14!

By tapping the corresponding torch trigger the welding current can be determined in an adjustable jump range. Each tap will cause the welding current to jump up or down by the defined value.

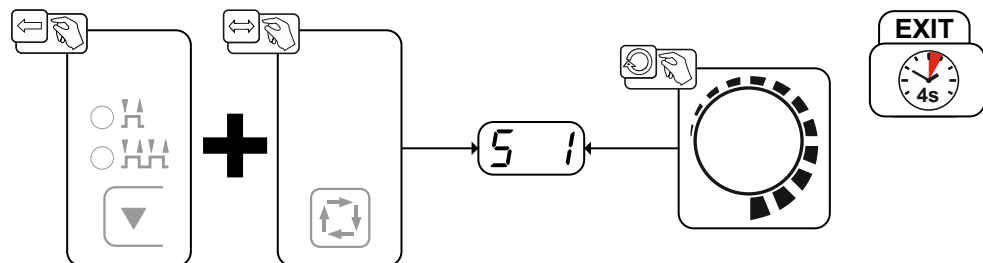

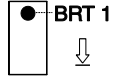
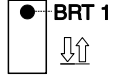

Figure 5-20



Display	Setting/selection
	Current jump
	<u>5 1</u> ----- 1 A
	<u>5 10</u> ----- 10 A

5.2.10.5 Standard TIG torch (5-pole)

Standard torch with one torch trigger

Figure	Operating elements	Explanation of symbols
		BRT1 = torch trigger 1 (welding current on/off; secondary current via tapping function)
Functions	Mode	Operating elements
Welding current on/off	1 (ex works)	
Secondary current (latched operation)		



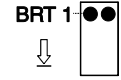
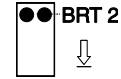
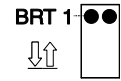
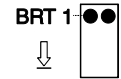
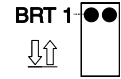
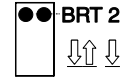
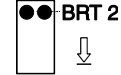









Standard torch with two torch triggers

Figure	Operating elements	Explanation of symbols
		BRT1 = torch trigger 1 BRT2 = torch trigger 2
Functions	Mode	Operating elements
Welding current on/off	1 (ex works)	
Secondary current		
Secondary current (tapping function) ¹ /(latched operating mode)		
Welding current on/off	3	
Secondary current (tapping function) ¹ /(latched operating mode)		
Up function ²		
Down function ²		

¹ > see 5.2.10.1 chapter

² > see 5.2.10.3 chapter

Standard torch with one rocker (rocker, two torch triggers)

Figure	Operating elements	Explanation of symbols	Functions	Mode	Operating elements
		BRT 1 = torch trigger 1 BRT 2 = torch trigger 2			
			Welding current on/off	1 (ex works)	
			Secondary current		
			Secondary current (tapping function ¹)/(latched operating mode)		
			Welding current on/off	2	
			Secondary current (tapping function ¹)		
			Up function ²		
			Down function ²		
			Welding current on/off	3	
			Secondary current (tapping function ¹)/(latched operating mode)		
			Up function ²		
			Down function ²		

¹ > see 5.2.10.1 chapter

² > see 5.2.10.3 chapter

5.2.10.6 TIG up/down torch (8-pole)

Up/down torch with one torch trigger

Figure	Operating elements	Explanation of symbols
		BRT 1 = torch trigger 1

Functions	Mode	Operating elements
Welding current on/off	1 (ex works)	
Secondary current (tapping function ¹)/(latched operating mode)		
Increase welding current (up function ²)		
Decrease welding current (down function ²)		
Welding current on/off	4	
Secondary current (tapping function ¹)/(latched operating mode)		
Increase welding current via current jump ³		
Decrease welding current via current jump ³		

¹ > see 5.2.10.1 chapter

² > see 5.2.10.3 chapter

³ > see 5.2.10.4 chapter

Up/down torch with two torch triggers

Figure	Operating elements	Explanation of symbols
		BRT 1 = torch trigger 1 (left) BRT 2 = torch trigger 2 (right)

Functions	Mode	Operating elements
Welding current on/off	1 (ex works)	BRT 1
Secondary current		BRT 2
Secondary current (tapping function ¹)/(latched operating mode)		BRT 1
Increase welding current (up function ²)		Up
Decrease welding current (down function ²)		Down
Modes 2 and 3 are not used with this type of torch or, respectively, are not appropriate.		
Welding current on/off	4	BRT 1
Secondary current		BRT 2
Secondary current (tapping function ¹)		BRT 1
Increase welding current via current jump ³		Up
Decrease welding current via current jump ³		Down
Gas test		BRT 2 > 3 s

¹ > see 5.2.10.1 chapter

² > see 5.2.10.3 chapter

³ > see 5.2.10.4 chapter

5.2.10.7 Potentiometer torch (8-pole)

The welding machine needs to be configured for operation with a potentiometer torch > see 5.2.10.8 chapter.

Potentiometer torch with one torch trigger

Figure	Operating elements	Explanation of symbols
		BRT 1 = torch trigger 1
Functions	Mode	Operating elements
Welding current on/off	3	
Secondary current (tapping function ¹)		
Increase welding current		
Decrease welding current		

Potentiometer torch with two torch triggers

Figure	Operating elements	Explanation of symbols
		BRT 1 = torch trigger 1 BRT 2 = torch trigger 2
Functions	Mode	Operating elements
Welding current on/off	3	
Secondary current		
Secondary current (tapping function ¹)		
Increase welding current		
Decrease welding current		

¹ > see 5.2.10.1 chapter

5.2.10.8 Configuring the TIG potentiometer torch connection

⚠ DANGER



Risk of injury due to electrical voltage after switching off!
Working on an open machine can lead to fatal injuries!
Capacitors are loaded with electrical voltage during operation. Voltage remains present for up to four minutes after the mains plug is removed.

1. Switch off machine.
2. Remove the mains plug.
3. Wait for at last 4 minutes until the capacitors have discharged!

⚠ WARNING



No improper repairs and modifications!
To prevent injuries and damage to the machine, only competent personnel (authorised service personnel) are allowed to repair or modify the machine.
Unauthorised manipulations will invalidate the warranty!

- Instruct competent personnel (authorised service personnel) to repair the machine.



Dangers resulting from failure to perform test after conversion!
Before reconnection, "Inspection and Testing during Operation" according to IEC/BS EN 60974-4 "Arc welding systems – Inspection and Testing during Operation" has to be performed!

- Perform test to IEC / DIN EN 60974-4!

When connecting a potentiometer torch, jumper JP1 on PCB T200/1 inside the welding machine should be unplugged.

Welding torch configuration	Setting
Prepared for TIG standard or up/down torch (factory setting)	<input checked="" type="checkbox"/> JP1
Prepared for potentiometer torches	<input type="checkbox"/> JP1

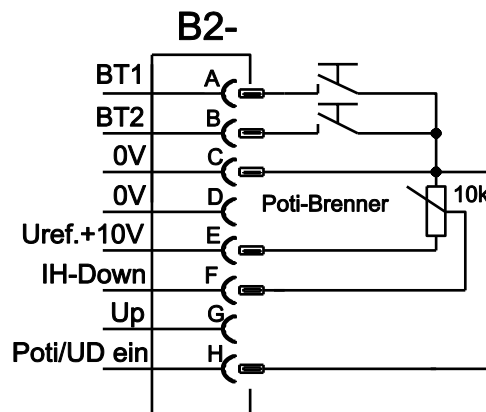

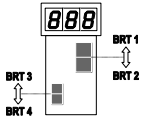

Figure 5-21

This torch type requires the welding machine to be set to torch mode 3 > see 5.2.10.2 chapter.

5.2.10.9 RETOX TIG torch (12-pole)

These accessory components can be retrofitted as an option > see 9 chapter.

Figure	Operating elements	Explanation of symbols
		BRT = Torch trigger

Functions	Mode	Operating elements
Welding current On/Off	1 (ex works)	BRT 1
Secondary current		BRT 2
Secondary current (tapping function ¹)		BRT 1 (tapping)
Increase welding current (up function ²)		BRT 3
Decrease welding current (down function ²)		BRT 4
Welding current On/Off	2	BRT 1
Secondary current		BRT 2
Secondary current (tapping function ¹)		BRT 1 (tapping)
Welding current On/Off	3	BRT 1
Secondary current		BRT 2
Secondary current (tapping function ¹)		BRT 1 (tapping)
Welding current on/off	4	BRT 1
Secondary current		BRT 2
Secondary current (tapping function ¹)		BRT 1 (tapping)
Increase welding current in steps (current jump ³)		BRT 3
Decrease welding current in steps (current jump ³)		BRT 4
Gas test		BRT 2 (3 s)

¹ > see 5.2.10.1 chapter

² > see 5.2.10.3 chapter

³ > see 5.2.10.4 chapter

5.2.11 Expert menu (TIG)

The Expert menu has adjustable parameters stored that don't require regular setting. The number of parameters shown may be limited, e.g. if a function is deactivated.

The setting ranges for the parameter values are summarised in the Parameter overview section > see 10.1 chapter.

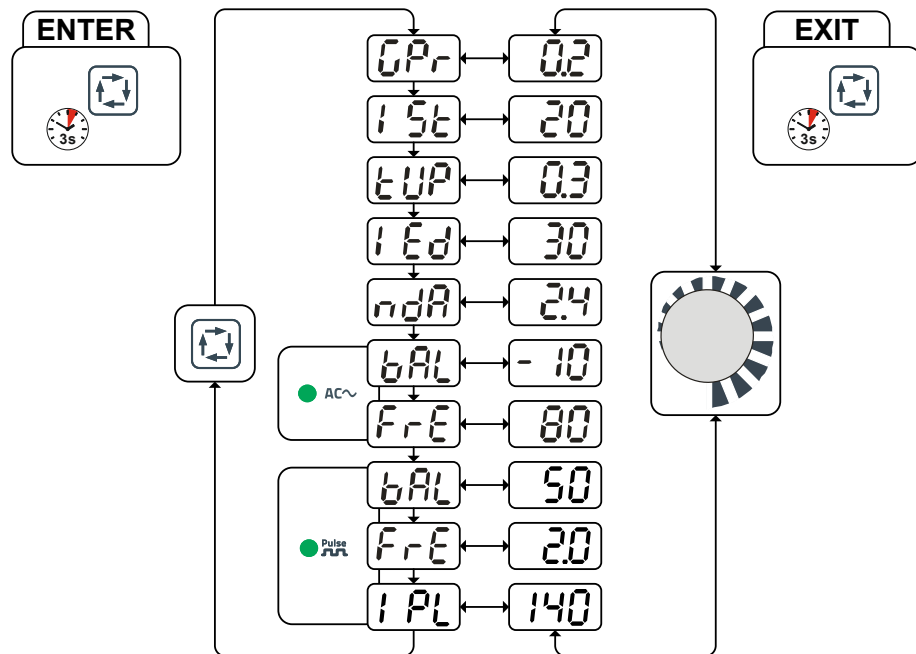

Figure 5-22

Display	Setting/selection
	Gas pre-flow time
	Start current Setting range in percent: depending on main current Setting range, absolute: Imin to Imax.
	Upslope time to main current
	End-crater current Setting range in percent: depending on main current Setting range, absolute: Imin to Imax.
	Diameter of tungsten electrode/ignition optimisation 1 mm to 4 mm or larger (0.1 mm increments)
	Alternating current balance (AC) Optimisation of cleaning and fusion penetration.
	AC frequency (AC)
	Pulse balance
	Pulse frequency
	Pulse current > see 5.2.8 chapter

5.3 MMA welding

5.3.1 Connecting the electrode holder and workpiece lead

⚠ CAUTION



Risk of crushing and burns!

When changing stick electrodes there is a risk of crushing and burns!

- Wear appropriate and dry protective gloves.
- Use an insulated pair of tongs to remove the used stick electrode or to move welded workpieces.



Electrical voltage at the shielding gas connection!

During MMA welding open circuit voltage is applied at the shielding gas connection (G $\frac{1}{4}$ " connecting nipple).

- Place yellow insulating cap on the G $\frac{1}{4}$ " connection nipple (protects against electrical voltage and dirt).

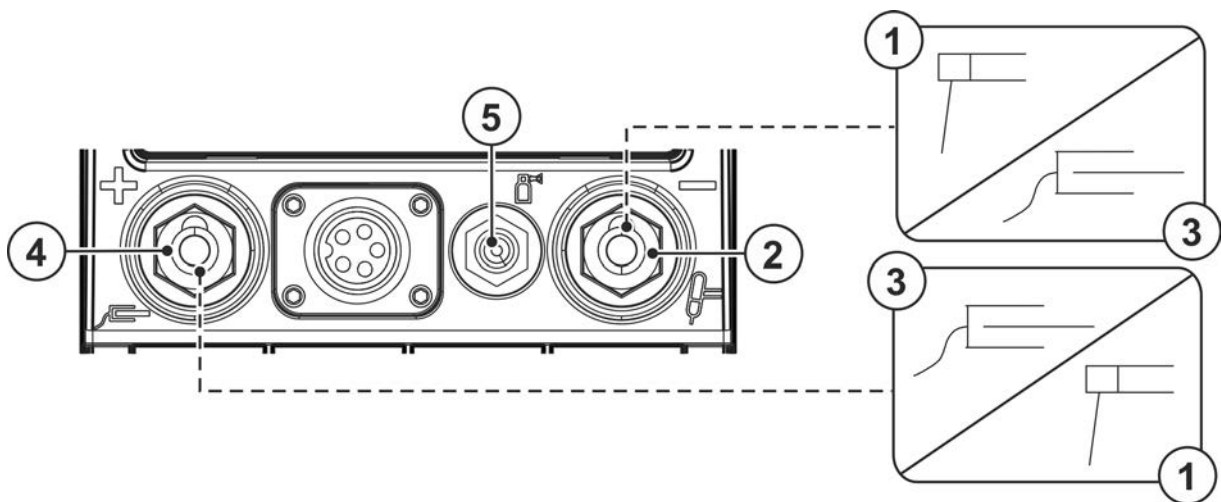

Figure 5-23

Item	Symbol	Description
1		Electrode holder
2		Connection socket, "-" welding current Workpiece lead or electrode holder connection
3		Workpiece
4		Connection socket for "+" welding current Electrode holder or workpiece lead connection
5		Connection thread - G$\frac{1}{4}$" Shielding gas connection (inlet)

- Insert the electrode holder plug and workpiece lead into the welding current socket depending on application and lock in place by turning to the right. The corresponding polarity will be based on the information of the electrode manufacturer on the electrode packaging.
- Fit yellow protective cap onto G $\frac{1}{4}$ " connecting nipple.

5.3.2 Welding task selection

It is only possible to change the basic parameters when no welding current is flowing and any possible access control is disabled > see 5.7 chapter.

The following welding task selection is an example of use. In general, the selection process always has the same sequence. Signal lights (LED) will show the selected combination.

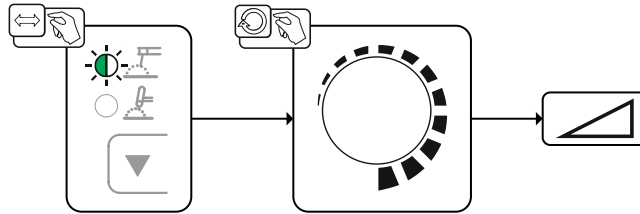

Figure 5-24

5.3.3 Hotstart

The function hot start ensures a secure igniting of the arc and a sufficient heating to the still cold parent metal at the beginning of the welding process. The ignition takes place here with increased current (hot start current) over a certain time (hot start time).

For parameter setting, > see 5.3.6 chapter.

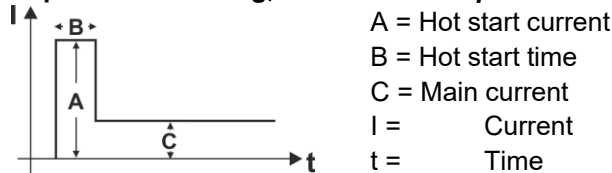
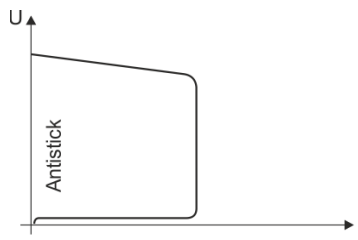

Figure 5-25

5.3.4 Antistick



The Antistick feature prevents the electrode from annealing.

Should the electrode stick despite the Arcforce feature, the machine automatically switches to the minimum current within approx. one second. This prevents the electrode from annealing. Check the welding current setting and correct for the welding task in hand.

Figure 5-26

5.3.5 Average value pulse welding

Average value pulse welding means that two currents are switched periodically, a current average value (AMP), a pulse current (I_{puls}), a balance (b_{RL}) and a frequency (F_{rE}) having been defined first. The predefined ampere current average value is decisive, the pulse current (I_{puls}) is defined by the I_{PL} parameter as a percentage of the current average value (AMP). The pulse pause current (IPP) requires no setting. This value is calculated by the machine control, so that the welding current average value (AMP) is maintained at all times.

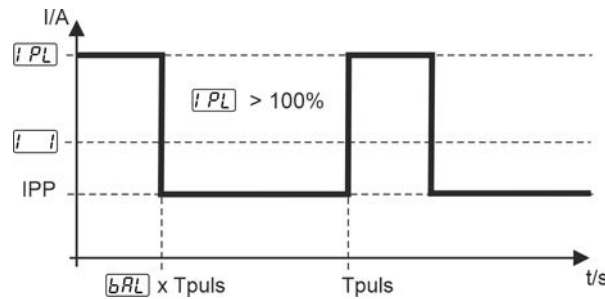

Figure 5-27

AMP = Main current; e.g. 100 A

I_{puls} = Pulse current = $I_{PL} \times AMP$; e.g. 140% x 100 A = 140 A

IPP = Pulse pause current

T_{puls} = Duration of one pulse cycle = $1/F_{rE}$; e.g. 1/1 Hz = 1 s

b_{RL} = Balance

For parameter setting, > see 5.3.6 chapter.

5.3.6 Expert menu (MMA)

The Expert menu has adjustable parameters stored that don't require regular setting. The number of parameters shown may be limited, e.g. if a function is deactivated.

The setting ranges for the parameter values are summarised in the Parameter overview section > see 10.1 chapter.

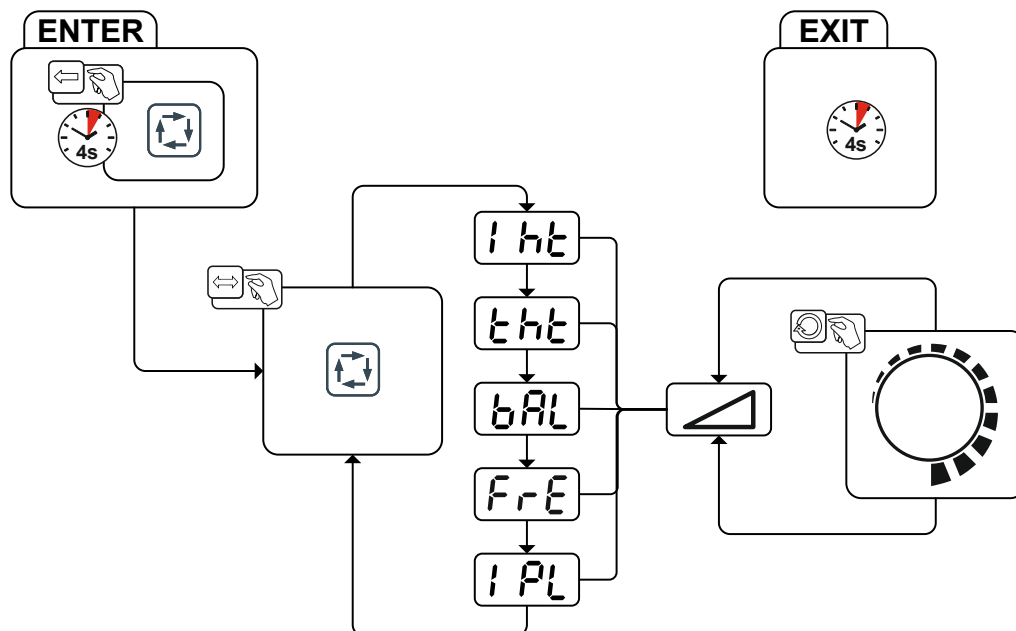

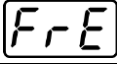
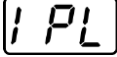

Figure 5-28

Display	Setting/selection
$I\ ht$	Hotstart current
$t\ ht$	Hotstart time

Display	Setting/selection
	Pulse balance
	Pulse frequency
	Pulse current > see 5.3.5 chapter

5.4 Voltage reducing device

Only machine variants with the (VRD/SVRD/AUS/RU) code are equipped with a voltage reduction device (VRD). The VRD is used for increased safety, especially in hazardous environments such as shipbuilding, pipe construction or mining.

A VRD is mandatory in some countries and required by many on-site safety instructions for power sources.

The VRD > see 4.2 chapter signal light is illuminated when the voltage reduction device is operating without fault and the output voltage is reduced to a value specified in the relevant standard (see technical data > see 8 chapter).

5.5 Remote control

The remote controls are operated on the 19-pole remote control connection socket (analogue).

5.5.1 RT1 19POL



Functions

- Infinitely adjustable welding current (0% to 100%) depending on the preselected main current on the welding machine.

5.5.2 RTG1 19POL



Functions

- Infinite setting of the welding current (0% to 100%) depending on the main current preselected at the welding machine

5.5.3 RTP1 19POL



Functions

- TIG/MMA
- Infinitely adjustable welding current (0% to 100%) depending on the preselected main current on the welding machine.
- Pulse/spot/normal
- Pulse, spot and break times are infinitely adjustable.

5.5.4 RTP2 19POL



Functions

- TIG/MMA.
- Infinitely adjustable welding current (0% to 100%) depending on the preselected main current on the welding machine.
- Pulse/spot/normal
- Frequency and spot times infinitely adjustable.
- Coarse adjustment of the cycle frequency.
- Pulse/pause ratio (balance) adjustable from 10% to 90%.

5.5.5 RTP3 spotArc 19POL

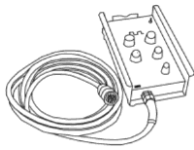

Functions

- TIG / MMA.
- Infinitely adjustable welding current (0% to 100%) depending on the preselected main current on the welding machine.
- Pulse / SpotArc spots / normal
- Frequency and spot time infinitely adjustable.
- Coarse adjustment of the pulse frequency.
- Pulse/pause ratio (balance) adjustable from 10% to 90%.

5.5.6 RTF1 19POL

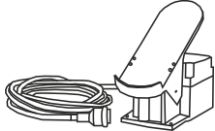

Functions

- Infinitely adjustable welding current (0% to 100%) depending on the preselected main current on the welding machine.
- Start/stop welding operation (TIG)

5.5.7 RTF-X TIG 19POL



Functions

- Infinitely adjustable welding current (0% to 100%) depending on the main current preselected at the welding machine.
- Welding process start/stop (TIG)

5.6 Interfaces for automation



Damage to the machine due to improper connection!

Unsuitable control leads or incorrect connection of input and output signals can cause damage to the machine.

- **Only use shielded control leads!**
- **If the machine is to be operated with control voltages connection via suitable isolation amplifiers is required!**
- **To control the main or secondary current via control voltages, the relevant inputs must be enabled (see specification for activation of control voltage).**

5.6.1 Remote control connection socket, 19-pole

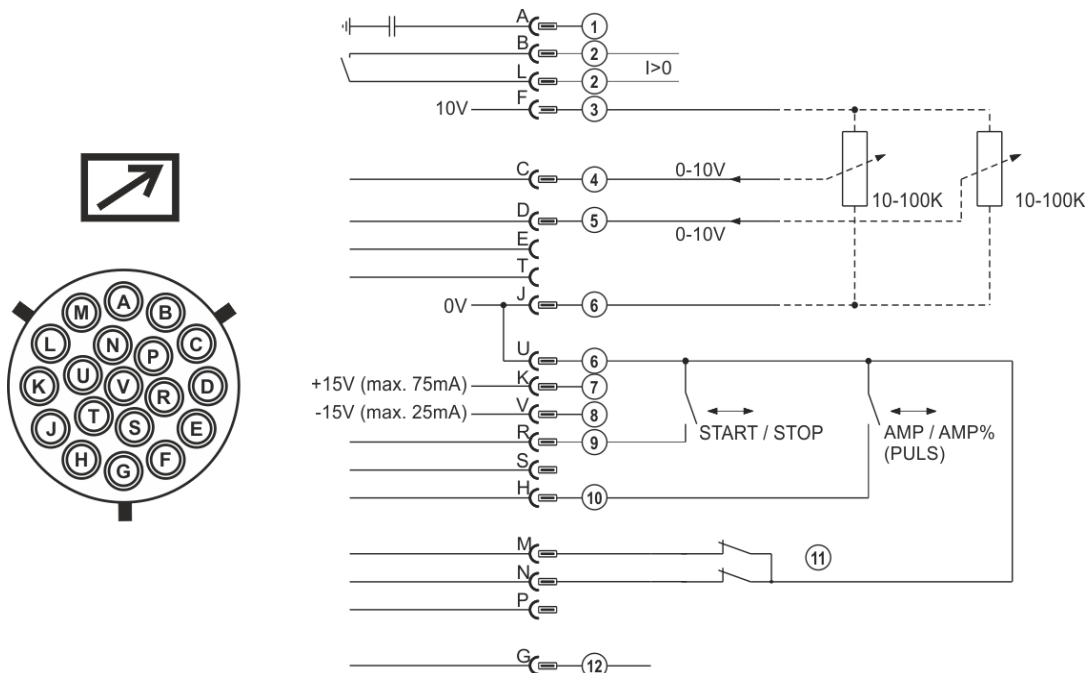

Figure 5-29

Item	Pin	Signal shape	Designation
1	A	Output	Connection for cable screen (PE)
2	B/L	Output	Current flowing signal $I > 0$, galvanically isolated (max. +/- 15V/100mA)
3	F	Output	Reference voltage for potentiometer 10V (max. 10mA)
4	C	Input	Control voltage specification for main current, 0–10V (0V = $I_{\min}/10V = I_{\max}$)
5	D	Input	Control voltage specification for secondary current, 0–10V (0V = $I_{\min}/10V = I_{\max}$)
6	J/U	Output	Reference potential 0V
7	K	Output	Power supply +15V, max. 75mA
8	V	Output	Power supply -15V, max. 25mA
9	R	Input	Start/Stop welding current
10	H	Input	Switching between main and secondary welding currents (pulses)
11	M/N	Input	Activation of control voltage specification Signals M and N must be set to reference potential 0V to activate the external control voltage specification for main and secondary current.

5.7 Access control

The machine control can be locked to secure it against unauthorised or unintentional adjustment. The access block has the following effect:

- The parameters and their settings in the machine configuration menu, Expert menu and operation sequence can only be viewed but not changed.
- Welding procedure and welding current polarity cannot be changed.

The parameters for the access block are configured in the machine configuration menu > see 5.9 chapter.

Enabling the access block

- Assign the access code for the access block: Select parameter $\boxed{U05}$ and select a number code (0–999).
- Enable access block: Set parameter to function \boxed{ON} .

Disabling the access block

- Enter the access code for the access block: Select parameter $\boxed{U05}$ and enter the number code (0–999).
- Disable access block: Set parameter to \boxed{OFF} .

The only way to disable the access block is to enter the selected number code.

Changing the access block

- Enter the access code for the access block: Select parameter $\boxed{E04}$ and enter the previously selected number code (0–999).
- Change the access block: Set parameter \boxed{NEC} and assign a new code (0–999).

5.8 Power-saving mode (Standby)

You can activate the power-saving mode by either pressing the push-button > see 4.2 chapter for a prolonged time or by setting a parameter in the machine configuration menu (time-controlled power-saving mode \boxed{SbA}) > see 5.9 chapter.

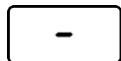

When power-saving mode is activated, the machine displays show the horizontal digit in the centre of the display only.

Pressing any operating element (e.g. turning a rotary knob) deactivates power-saving mode and the machine is ready for welding again.

5.9 Machine configuration menu

Basic machine settings are defined in the machine configuration menu.

5.9.1 Selecting, changing and saving parameters

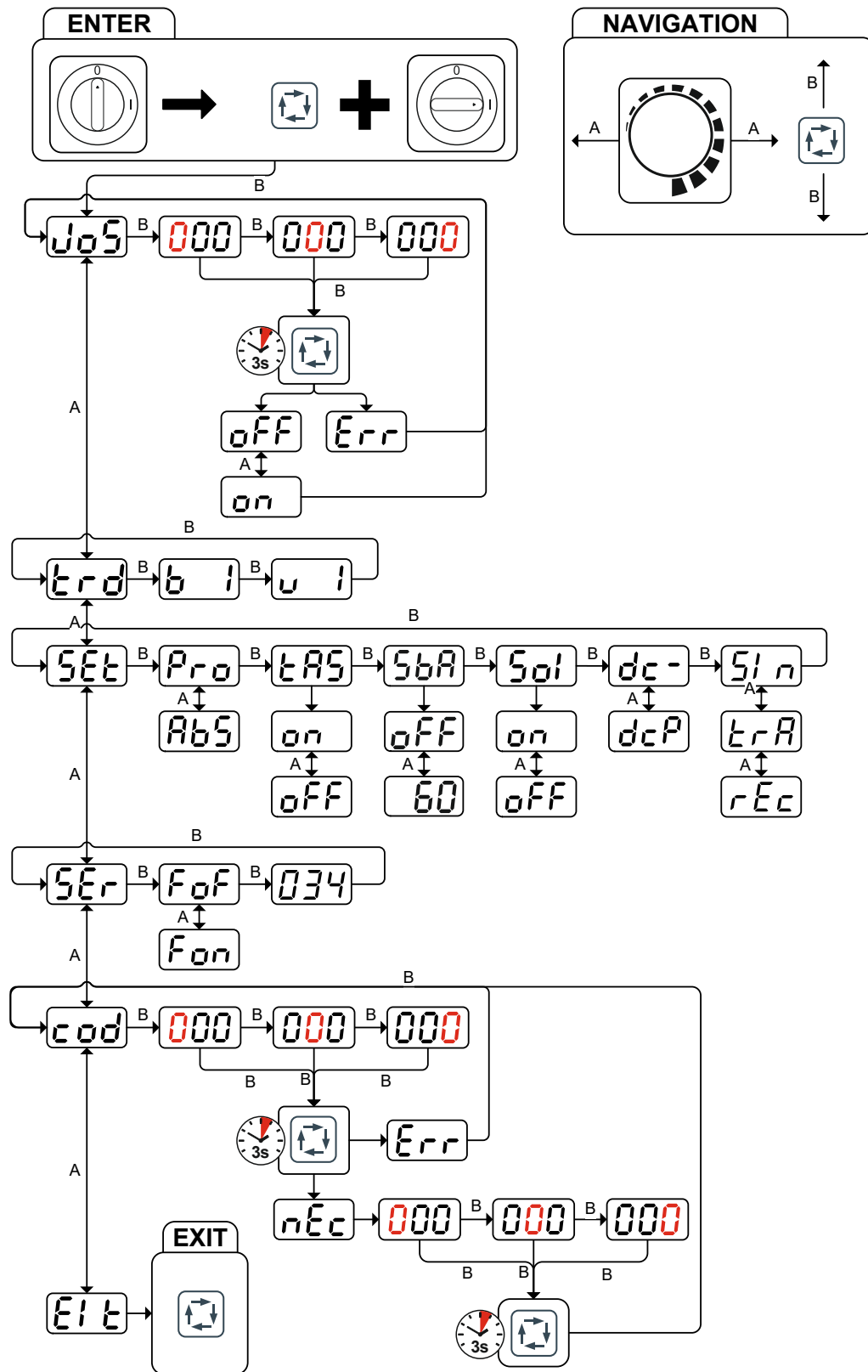
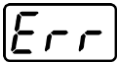
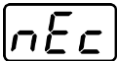

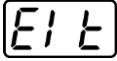



Figure 5-30

Display	Setting/selection
	Lock JOB menu Protect welding parameters from unauthorised access.

Display	Setting/selection
000	Machine code Querying the three-digit machine code (000 to 999), user input
Err	Error Error message after entering an incorrect machine code
on	Switch on Switching on machine function
off	Switch off Switching off machine function
trd	Torch configuration menu Set welding torch functions
b 1	Torch mode setting (factory setting 1)
u 1	Up/Down speed (not available in modes 4 and 14) Increase value = rapid current change Decrease value = slow current change
SEt	Settings Settings for machine functions and parameter displays.
Pro	Welding current display, percentage Representation of the welding current as a percentage in relation to the main current setting (AMP). Example: Main current setting to 120A and secondary current to 50% results in an absolute secondary current of 60A.
ABS	Welding current display, absolute Absolute representation of all welding currents in amperes
TR5	TIG antistick > see 5.2.9 chapter on ----- function active (factory setting). off ----- function inactive.
5bA	Time-based power-saving mode > see 5.8 chapter Time to activation of the power-saving mode in case of inactivity. Setting off = disabled or numerical value 5-60 min..
5o1	TIG HF start (soft/hard) switching on ----- soft ignition (factory setting). off ----- hard ignition.
dc-	Negative welding current polarity during the ignition phase
dcP	Positive welding current polarity during the ignition phase
51n	Alternating current welding with sinusoidal current waveform Low noise level
trA	Alternating current welding with trapezoidal current waveform An all-rounder, suitable for most applications
rEc	AC welding with rectangular current waveform (ex works) Highest energy input
SEr	Service menu Service settings
FoF	Machine fan test Machine fan is switched off
Fon	Machine fan test Machine fan is switched on
034	Software version of the machine control Version display (example 034 = version 34)
cod	Access control – access code Setting: 000 to 999 (000 ex works)

Display	Setting/selection
	Error Error message after entering an incorrect machine code
	New machine code <ul style="list-style-type: none">• Machine code entered correctly• Prompt for entering the new machine code
	Machine code Querying the three-digit machine code (000 to 999), user input
	Exit the menu Exit
	Numerical value – adjustable

6 Maintenance, care and disposal

6.1 General

DANGER



Risk of injury due to electrical voltage after switching off!

Working on an open machine can lead to fatal injuries!

Capacitors are loaded with electrical voltage during operation. Voltage remains present for up to four minutes after the mains plug is removed.

1. Switch off machine.
2. Remove the mains plug.
3. Wait for at last 4 minutes until the capacitors have discharged!

WARNING



Improper maintenance, testing and repairs!

Maintenance, testing and repair of the machine may only be carried out by skilled and qualified personnel (authorised service personnel). A competent person is someone who, based on training, knowledge and experience, can recognize the hazards and possible consequential damage that may occur when testing power sources and can take the necessary safety precautions.

- Follow the maintenance instructions > see 6.2 chapter.
- If any of the test requirements below are not met, the unit must not be put back into operation until it has been repaired and tested again.

Repair and maintenance work may only be performed by qualified authorised personnel; otherwise the right to claim under warranty is void. In all service matters, always consult the dealer who supplied the machine. Return deliveries of defective equipment subject to warranty may only be made through your dealer. When replacing parts, use only original spare parts. When ordering spare parts, please quote the machine type, serial number and item number of the machine, as well as the type designation and item number of the spare part.

Under the specified ambient conditions and normal working conditions this machine is essentially maintenance-free and requires just a minimum of care.

Contamination of the machine may impair service life and duty cycle. The cleaning intervals depend on the ambient conditions and the resulting contamination of the machine. The minimum interval is every six months.

6.1.1 Cleaning

- Clean the outer surfaces with a moist cloth (no aggressive cleaning agents).
- Purge the machine venting channel and cooling fins (if present) with oil- and water-free compressed air. Compressed air may overspeed and destroy the machine fans. Never direct the compressed air directly at the machine fans. Mechanically block the fans, if required.
- Check the coolant for contaminants and replace, if necessary.

6.1.2 Dirt filter

When using a dirt filter, the cooling air throughput is reduced and the duty cycle of the machine is reduced as a result. The duty cycle decreases with the increasing contamination of the filter. The dirt filter must be removed at regular intervals and cleaned by blowing out with compressed air (depending on the level of soiling).

6.2 Maintenance work, intervals

6.2.1 Daily maintenance tasks

Visual inspection

- Mains supply lead and its strain relief
- Gas cylinder securing elements
- Check hose package and power connections for exterior damage and replace or have repaired by specialist staff as necessary!
- Gas tubes and their switching equipment (solenoid valve)
- Check that all connections and wearing parts are hand-tight and tighten if necessary.
- Check correct mounting of the wire spool.
- Wheels and their securing elements
- Transport elements (strap, lifting lugs, handle)
- Other, general condition

Functional test

- Operating, message, safety and adjustment devices (Functional test)
- Welding current cables (check that they are fitted correctly and secured)
- Gas tubes and their switching equipment (solenoid valve)
- Gas cylinder securing elements
- Check correct mounting of the wire spool.
- Check that all screw and plug connections and replaceable parts are secured correctly, tighten if necessary.
- Remove any spatter.
- Clean the wire feed rollers on a regular basis (depending on the degree of soiling).

6.2.2 Monthly maintenance tasks

Visual inspection

- Casing damage (front, rear and side walls)
- Wheels and their securing elements
- Transport elements (strap, lifting lugs, handle)
- Check coolant tubes and their connections for impurities

Functional test

- Selector switches, command devices, emergency stop devices, voltage reducing devices, message and control lamps
- Check wire guide elements (wire feed roll holder, wire feed nipple, wire guide tube) for tight fit. Recommendation for replacing the wire feed roll holder (eFeed) after 2000 hours of operation, see replacement parts).
- Check coolant tubes and their connections for impurities
- Check and clean the welding torch. Deposits in the torch can cause short circuits and have a negative impact on the welding result, ultimately causing damage to the torch.

6.2.3 Annual test (inspection and testing during operation)

A periodic test according to IEC 60974-4 "Periodic inspection and test" has to be carried out. In addition to the regulations on testing given here, the relevant local laws and regulations must also be observed. For more information refer to the "Warranty registration" brochure supplied and our information regarding warranty, maintenance and testing at www.ewm-group.com!

6.3 Disposing of equipment



Proper disposal!

The machine contains valuable raw materials, which should be recycled, and electronic components, which must be disposed of.

- Do not dispose of in household waste!
- Observe the local regulations regarding disposal!

In addition to the national or international regulations mentioned below, it is mandatory to follow the respective national laws and regulations on disposal.

- According to European provisions (Directive 2012/19/EU on Waste of Electrical and Electronic Equipment), used electric and electronic equipment may no longer be placed in unsorted municipal waste. It must be collected separately. The symbol depicting a waste container on wheels indicates that the equipment must be collected separately.

This machine has to be disposed of, or recycled, in accordance with the waste separation systems in use.

According to German law (law governing the distribution, taking back and environmentally correct disposal of electrical and electronic equipment (ElektroG)), used machines are to be placed in a collection system separate from unsorted municipal waste. The public waste management utilities (communities) have created collection points at which used equipment from private households can be disposed of free of charge.

The deletion of personal data is the responsibility of the end user.

Lamps, batteries or accumulators must be removed and disposed of separately before disposing of the device. The type of battery or accumulator and its composition is marked on the top (type CR2032 or SR44). The following EWM products may contain batteries or accumulators:

- Welding helmets
Batteries or accumulators are easy to remove from the LED cassette.
- Device controls
Batteries or accumulators are located on the back of these in corresponding sockets on the circuit board and are easy to remove. The controls can be removed using standard tools.

Information on returning used equipment or collections can be obtained from the respective municipal administration office. Devices can also be returned to EWM sales partners across Europe.

Further information on the topic of the disposal of electrical and electronic equipment can be found on our website at: <https://www.ewm-group.com/de/nachhaltigkeit.html>.

7 Rectifying faults

All products are subject to rigorous production checks and final checks. If, despite this, something fails to work at any time, please check the product using the following flowchart. If none of the fault rectification procedures described leads to the correct functioning of the product, please inform your authorised dealer.

7.1 Checklist for rectifying faults

The correct machine equipment for the material and process gas in use is a fundamental requirement for perfect operation!

Legend	Symbol	Description
	↙	Fault/Cause
	✘	Remedy

Mains fuse triggers

- ↙ Mains fuse triggers - unsuitable mains fuse
 - ✘ Set up recommended mains fuse > see 8 chapter.

Functional errors

- ↙ Several parameters cannot be set (machines with access block)
 - ✘ Entry level is blocked, disable access lock > see 5.7 chapter
- ↙ All machine control signal lights are illuminated after switching on
- ↙ No machine control signal light is illuminated after switching on
- ↙ No welding power
 - ✘ Phase failure > check mains connection (fuses)
- ↙ Connection problems
 - ✘ Make control lead connections and check that they are fitted correctly.
- ↙ Loose welding current connections
 - ✘ Tighten power connections on the torch and/or on the workpiece
 - ✘ Tighten contact tip correctly

No arc ignition

- ↙ Incorrect ignition type setting.
 - ✘ Ignition type: Select "HF start". Depending on the machine, the setting is defined by the change-over switch for ignition types or the hF parameter in one of the machine menus (see the "Control operating instructions", if applicable).

Bad arc ignition

- ↙ Material inclusions in the tungsten electrode due to contact with filler material or workpiece
 - ✘ Regrind or replace the tungsten electrode
- ↙ Bad current transfer on ignition
 - ✘ Check the setting on the "Tungsten electrode diameter/Ignition optimisation" rotary dial and increase if necessary (higher ignition energy).

Welding torch overheated

- ↙ Loose welding current connections
 - ✘ Tighten power connections on the torch and/or on the workpiece
 - ✘ Tighten contact tip correctly
- ↙ Overload
 - ✘ Check and correct welding current setting
 - ✘ Use a more powerful welding torch

Unstable arc

- ✓ Material inclusions in the tungsten electrode due to contact with filler material or workpiece
 - ✗ Regrind or replace the tungsten electrode
- ✓ Incompatible parameter settings
 - ✗ Check settings and correct if necessary

Pore formation

- ✓ Inadequate or missing gas shielding
 - ✗ Check shielding gas setting and replace shielding gas cylinder if necessary
 - ✗ Shield welding site with protective screens (draughts affect the welding result)
 - ✗ Use gas lens for aluminium applications and high-alloy steels
- ✓ Unsuitable or worn welding torch equipment
 - ✗ Check size of gas nozzle and replace if necessary
- ✓ Condensation in the gas tube
 - ✗ Purge hose package with gas or replace

7.2 Error messages (power source)

A welding machine error is indicated by the collective fault signal lamp (A1) lighting up and an error code (see table) being displayed in the machine control display. In the event of a machine error, the power unit shuts down.

The possible error numbers displayed depend on the machine series and version!

- If multiple errors occur, these are displayed in succession.
- Document machine errors and inform service staff as necessary.

Error message	Possible cause	Remedy
E 1	Water fault Only occurs if a water cooling unit is connected.	Ensure that sufficient water pressure can be built up. (e.g. top up water)
E 2	Temperature error	Allow machine to cool down.
E 3	Electronics error	Switch machine off and on again. If the fault persists, inform the service department.
E 4	see "E 3"	see "E 3"
E 5	see "E 3"	see "E 3"
E 6	Balancing error in voltage recording.	Switch machine off, place the torch on an insulated surface and switch on again. If the fault persists, inform the service department.
E 7	Balancing error in current recording.	Switch machine off, place the torch on an insulated surface and switch on again. If the fault persists, inform the service department.
E 8	Error in one of the electronics supply voltages or excess temperature of the welding transformer.	Allow machine to cool down. If the error message persists, switch the machine off and back on again. If the fault persists, inform the service department.
E 9	Low voltage	Switch off the machine and check the mains voltage.
E10	Secondary overvoltage	Switch machine off and on again. If the fault persists, inform the service department.
E11	Overvoltage	Switch off the machine and check the mains voltage.
E12	VRD (open circuit voltage reduction error)	Inform Service

7.3 Resetting welding parameters to the factory settings

All customised welding parameters that are stored will be replaced by the factory settings.

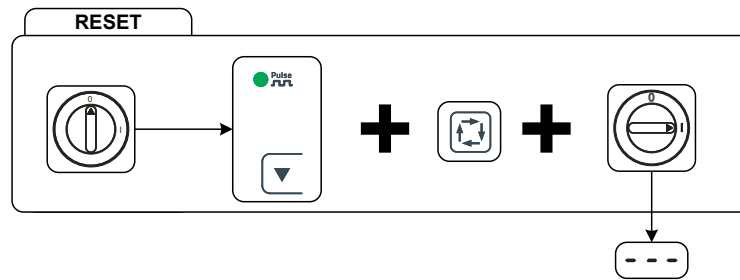

Figure 7-1

Display	Setting/selection
- - -	Input confirmation User entries are applied, release button(s).





7.4 Software version of the machine control

The query of the software versions only serves to inform the authorised service staff. It is available in the machine configuration menu > see 5.9 chapter.

8 Technical data

Performance specifications and guarantee only in connection with original spare and replacement parts!

8.1 Picotig 200 AC/DC

	TIG	MMA
Welding current (I ₂)	3 A to 200 A	5 A to 140 A
Welding voltage according to standard (U ₂)	10,1 V to 18,0 V	20,2 V to 25,6 V
Duty cycle DC at 40° C ^[1]		
35 %	200 A	
50 %		140 A
60 %	150 A	130 A
100 %	140 A	110 A
Open circuit voltage (U ₀)	43 V	
Mains voltage (Tolerance)	1 x 230 V (-40 % to +15 %)	
Frequency	50/60 Hz	
mains fuse ^[2]	1 x 16 A	
Mains connection cable	H07RN-F3G2,5	
max. Connected load (S ₁)	6,0 kVA	
Generator rating (Rec.)	8,1 kVA	
Power consumption P _i ^[3]	24 W	
Cos φ / efficiency	0,99 / 85 %	
Protection class / Overvoltage category	I / III	
Contamination level	3	
Insulation class / protection classification	H / IP 23	
Residual current circuit breaker	Type B (recommended)	
Noise level ^[4]	<70 dB(A)	
Ambient temperature ^[5]	-25 °C to +40 °C	
Machine cooling / Torch cooling	Fan (AF) / gas	
Workpiece lead (min.)	35 mm ²	
EMC class	A	
Test mark	 /  /  / 	
Standards used	See declaration of conformity (appliance documents)	
Dimensions (l x b x h)	539 x 210 x 415 mm	
	21.2 x 8.3 x 16.3 inch	
Weight	16,5 kg	
	36.4 lb	

^[1] Load cycle: 10 min. (60 % DC \triangleq 6 min. welding, 4 min. pause)

^[2] Safety fuses are recommended DIAZED xxA gG. When using automatic cutouts, the "C" trigger characteristic must be used.

^[3] Power in idle state without external or internal peripherals.

^[4] Noise level during idle mode and operation under standard load according to IEC 60974- 1 at the maximum operating point.

^[5] Ambient temperature dependent on coolant! Observe coolant temperature range!

9 Accessories

Performance-dependent accessories like torches, workpiece leads, electrode holders or intermediate hose packages are available from your authorised dealer.

9.1 Welding torch cooling system

Type	Designation	Item no.
cool40 U31	Cooling module	090-008593-00502

9.2 Transport system

Type	Designation	Item no.
Trolly 35.2-2	Transport vehicle	090-008296-00000
Trolly 55-5	Transport cart, assembled	090-008632-00000
Trolly 55-6	Transport cart, assembled	090-008825-00000

9.3 Remote controls and accessories

Type	Designation	Item no.
RTF-X TIG 19pol 5 m	Foot-operated remote control, current, with connection cable	090-008855-00005
RTF1 19POL 5 M	Foot-operated remote control current with connection cable	094-006680-00000
RT1 19POL	Remote control current	090-008097-00000
RTG1 19POL 5m	Remote control, current	090-008106-00000
RTG1 19POL 10m	Remote control, current	090-008106-00010
RTP1 19POL	Remote control spot welding / pulses	090-008098-00000
RTP2 19POL	Remote control spot welding / pulses	090-008099-00000
RTP3 spotArc 19POL	spotArc remote control for spot welding / pulses	090-008211-00000

9.3.1 Connection cables

Type	Designation	Item no.
RA5 19POL 5M	Remote control e.g. connection cable	092-001470-00005
RA10 19POL 10m	Remote control e.g. connection cable	092-001470-00010
RA20 19POL 20m	Remote control e.g. connection cable	092-001470-00020

9.4 Option for retrofitting

Type	Designation	Item no.
ON TG	Carrying strap	092-004310-00000
ON TH TG.03/TG.04/TG.11 R	Torch holder, right	092-002699-00000
ON Filter TG.0002	Retrofit option, dirt filter for air inlet	092-002551-00000
ON PC PLUG	Protective cap for plug	092-003074-00000

9.5 Option for conversion

9.5.1 Machine control Comfort

⚠ CAUTION



Risk of injury and equipment damage due to inadequate training!

The conversion options listed below generally involve opening the device. An opened machine poses various dangers (e.g., electrical voltages, hot coolant, etc.). Dangerous voltages can still be present in power sources even after they have been switched off.

- Only knowledgeable, qualified service personnel with appropriate training may carry out conversions.! Qualified people are those who, based on their training, knowledge and experience, can recognise the hazards and possible consequential damage that arise when testing welding power sources and take the necessary safety precautions. The unauthorised intervention will void the warranty.

Type	Designation	Item no.
ON 8pol	8-pole connection socket	092-002465-00000
ON 12pol Retox TG.0002	Optional retrofit 12-pole connection socket, torch	092-002519-00000

9.6 Shielding gas supply (shielding gas cylinder for welding machine)



















Type	Designation	Item no.
Proreg Ar/CO2 230bar 15l D	Pressure regulator with manometer	394-008488-10015
Proreg Ar/CO2 230bar 30l D	Pressure regulator with manometer	394-008488-10030
DM 842 Ar/CO2 230bar 15l D	Pressure regulator with manometer	394-002910-00015
DM 842 Ar/CO2 230bar 30l D	Pressure regulator with manometer	394-002910-00030
GH 2X1/4" 2M	Gas hose	094-000010-00001
GH 2x1/4" 3m	Gas hose	094-000010-00003
GH 2X1/4" 5m	Gas hose	094-000010-00005
GH 2X1/4" 10 m	Gas hose	094-000010-00011
GH 2X1/4" 15m	Gas hose	094-000010-00015

9.7 General accessories

Type	Designation	Item no.
GH L85MM GR1	Grinding aid	098-000704-00000
GH L175MM GR2	Grinding aid	098-003872-00000
SKGS 16A 250V CEE7/7, DIN 49440/441	Protective contact plug, solid rubber	094-001756-00000
ADAP CEE16/SCHUKO	Earth contact coupling/CEE16A plug	092-000812-00000

10 Appendix

10.1 Parameter overview – setting ranges

Welding data display (3-digit)	Parameters/function	Setting range			
		Standard (ex works)	min.	max.	Unit
TIG (TIG)					
	Gas pre-flow time	0,2	0,1	- 5	s
	Start current	20	1	- 200	%
	Up-slope time, non-latched operation	0,3	0,0	- 20,0	s
	Up-slope time, latched operation	1,0	0,0	- 20,0	s
-	Secondary current AMP%	50	1	- 200	%
-	Down-slope time, non-latched operation	0,1	0	20	s
-	Down-slope time, latched operation	1,0	0	20	s
	End current	30	1	- 200	%
	Gas post-flow time	8	0,1	20	s
	Diameter of tungsten electrode/ignition optimisation	2,4	1	- 4	mm
	AC balance	-10	30	- -30	
	AC frequency	80	50	- 200	Hz
	Pulse balance	50	1	- 99	%
	Pulse frequency DC	2,8	0,2	- 2000	Hz
	Pulse frequency AC	2,8	0,2	5,0	Hz
	Pulse current	140	1	- 200	%
MMA (MMA)					
	Hot start current	150	1	- 150	%
	Hot start time	0,1	0,0	- 5,0	s
	Pulse balance	30	1	- 99	%
	Pulse frequency	1,2	0,2	- 50	Hz
	Pulse current	142	1	- 200	%
Basic parameters (independent of procedure)					
	Time-based power-saving mode	20	off	- 60	min.
	Access control – access code	000	000	- 999	

10.2 Average shielding gas usage

	Gas nozzle number	4	5	6	7	8	10
	Ø mm	6.5	8.0	9.5	11	12.5	16
	Ø inch	0.26	0.31	0.37	0.43	0.5	0.63
l/min		6	8	10	12		15
gal/min		1.58	2.11	2.64	3.17		3.96

10.3 Searching for a dealer

Sales & service partners
www.ewm-group.com/en/specialist-dealers



"More than 400 EWM sales partners worldwide"