

WELDING MACHINES

PEGAS 320 AC/DC PULSE PEGAS 400 AC/DC PULSE

OPERATING MANUAL

CONTENT:

1.	INTRODUCTION	3
2.	SAFETY PRECAUTIONS	4
3.	OPERATING CONTROLS.....	5
4.	TECHNICAL DATA	6
5.	EQUIPMENT	8
6.	OPERATOR CONTROLS.....	10
7.	GETTING STARTED	15
8.	TWO STROKE AND FOUR STROKE IN TIG MODE.....	23
9.	JOB.....	24
10.	RESET	25
11.	ROUTINE MAINTANCE & INSPECTION.....	25
12.	STATEMENT OF WARRANTY	25
13.	DISPOSAL	26
14.	WARRANTY LIST	26

1. INTRODUCTION

Dear consumer,

Company ALFA IN a.s. thanks you for buying our product and believe that you will be satisfied with our machine.

This Operating Manual has been designed to instruct you on the correct use and operation of your ALFA IN product. Your satisfaction with this product and its safe operation is our ultimate concern. Therefore please take the time to read the entire manual, especially the Safety Precautions. They will help you to avoid potential hazards that may exist when working with this product.

Read and understand this entire Manual and your employer's safety practices before installing, operating, or servicing the equipment. While the information contained in this Manual represents the Manufacturer's best judgement, the Manufacturer assumes no liability for its use.

PEGAS 320 and 400 AC/DC PULSE weld by those methods:

1. TIG (PULSE) DC (Lift arc or High Frequency ignition)
2. TIG (PULSE) AC (Lift arc or High Frequency ignition)
3. MMA DC coated electrodes
4. MMA AC coated electrodes

PEGAS 320 and 400 AC/DC PULSE have these special functions for effective use: Pre gas and Post gas of protective gas, Up slope and Down slope, Starting current and Final current, HF ignition, 2T and 4T mode, Aluminum cleaning level, Pulsed mode, AC balance and Up-down control from the torch.

For MMA method are these machines equipped with functions Hot Start, Arc Force and Antistick.

Welding machine may be operated only by trained persons and only in the technical provisions. Company ALFA IN a.s. accept no responsibility for damage caused by improper use. Before commissioning please read carefully this manual.

The machine complies with the appropriate CE mark.

For maintenance and repairs, use only original spare parts. There is of course a complex of our services.

We reserve the law of adjustments and changes in case of printing errors, change of technical paramaters, accessories etc. without previous notice. These changes may not be reflected in the manuals for use in paper or electronic form.



2. SAFETY PRECAUTIONS

PERSONAL PROTECTION



1. For safety reasons, it is necessary to use welding gloves during welding. These gloves will protect you before intervention of electric current (open circuit voltage). It protects you against thermal radiation and splashing drops of hot metal too. Wear sturdy isolated shoes. Do not wear open shoes, because drops of hot metal can cause burns.
2. Do not look into the welding arc without eye and face protection. Always use good quality welding helmet with intact protective filter.
3. The persons appearing in the vicinity of the welding must be informed of the danger and must be equipped with protective equipment.
4. During welding, especially in small spaces, it is necessary to ensure an adequate supply of fresh air, because during welding, harmful fumes arise.
5. In tanks of gas, oil, fuel, etc., (even empty ones) do not make welding, because there is a chance of explosion.
6. In areas with chance of explosion special provisions are applied.
7. Welding machines that are subjected to great exertion must comply with specific security requirements. These include the rail pressure of the vessel etc. These connections may only be carried out by competently trained welders with the necessary permissions.

SAFETY REGULATIONS

1. Before starting work with welding machine it is necessary to get familiar with the provisions of the ČSN 050601 and norm ČSN 050630.
2. With a bottle of CO₂ or mixed gases should be handled according to the regulations for working with pressure vessels contained in ČSN 07 83 05.
3. The welder must use protective equipment.
4. Before working on the electrical part, removing the cover or cleaning it is necessary to disconnect the device from the network.

3. OPERATING CONTROLS

1. Putting the machine into operation can be performed only by trained personnel and only within the technical provisions. The manufacturer is not liable for damages resulting from improper use or handling. For maintenance and repair, use only original spare parts from ALFA IN.
2. Device complies with IEC 61000-3-12.
3. The welding machine is tested according to the degree of protection IP 23S, which provides protection against the intrusion of solid bodies with a diameter greater than 12 mm and protection against ingress of water, falling on the machine in a vertical direction or max degree of 60°.
4. Working ambient temperature between -10 and +40 °C.
5. Relative humidity below 90% at +20 °C.
6. Up to 3000 m altitude.
7. The machine must be positioned so that cooling air can enter and leave through cooling vents with no problem. It is necessary to ensure that there are no mechanical equipment, especially metal particles (e.g. during grinding) drawn into the machine.
8. It is necessary for welding machine to undergo a periodic inspection every 6/12 months by an authorized officer according to ČSN 331500 and ČSN 050630 – see Maintenance and service tests.
9. All interventions in the el. equipment as well as repair (removal of the plug, fuse replacement) should be performed by an authorized person.
10. With competent mains voltage and input must match the plug.
11. When welding aluminum alloys, we recommend following the technological preparation procedure before welding and thoroughly mechanically cleaning the aluminum oxides.

 **Caution**  **Extension cables must not have conductors with a smaller cross section than 4x2,5 mm² (for machine PEGAS 320 AC/DC PULSE) and 4x4 mm² (for machine PEGAS 400 AC/DC PULSE). The machine can be operated on a three-phase electric generator 19 kVA – for PEGAS 320 AC/DC PULSE (for PEGAS 400 AC/DC PULSE 25 kVA) (3x400V/50Hz) and more, which has ensured voltage stabilization ± 10%. Generators with lower power can damage the machine.**

12. It is necessary to protect the machine against:
 - a. Moisture and rain
 - b. Chemically aggressive environments
 - c. Mechanical damage
 - d. Draft and possibly ventilation of neighboring machines
 - e. Excessive overloading – exceeding tech. parameters
 - f. Rough treatment

ELECTROMAGNETIC COMPATIBILITY

The welding device is in terms of interference designed primarily for industrial areas. It meets the requirements of EN 60974-10 class A and it isn't designed for using in residential areas, where the electrical energy is supplied by public low-voltage power supply network. It can be here potential problems with ensuring of electromagnetic compatibility in this areas, due to interference caused by power lines as well as the radiated interference.

During operation, the device may be the source of interference.

 Caution 

We warn users, that they are responsible for possible interference from welding.

4. TECHNICAL DATA

PEGAS 320 AC/DC PULSE					
Method		MMA - AC	MMA - DC	TIG - AC	TIG - DC
Mains voltage	V/Hz	3 x 400/50-60			
Welding current range	A	10 - 320	10 - 320	10 - 320	10 - 320
Open-circuit voltage U_{20}	V	---	75,0	---	75,0
Mains protection	A	25 @			
Max. effective current I_{1eff}	A	21,0	19,4	15,1	14,3
Welding current (DC=100%) I_2	A	250		250	
Welding current (DC=60%)	A	320		320	
Welding current (DC=x%) I_2	A	60%=320		60%=320	
Protection		IP23S			
Standards		EN 60974-1, EN 60974-10 cl. A			
Dimensions (w x l x h)	mm	240 x 600 x 440			
Weight	kg	25,2			

PEGAS 400 AC/DC PULSE					
Method		MMA - AC	MMA - DC	TIG - AC	TIG - DC
Mains voltage	V/Hz	3 x 400/50-60			
Welding current range	A	10 - 400	10 - 400	10 - 400	10 - 400
Open-circuit voltage U_{20}	V	---	75,0	---	75,0
Mains protection	A	32 @			
Max. effective current I_{1eff}	A	26,4	26,3	20,0	19,4
Welding current (DC=100%) I_2	A	320		320	
Welding current (DC=60%)	A	400		400	
Welding current (DC=x%) I_2	A	60%=400		60%=400	
Protection		IP23S			
Standards		EN 60974-1, EN 60974-10 cl. A			
Dimensions (w x l x h)	mm	240 x 600 x 440			
Weight	kg	26,7			



COOLING UNIT		
Cooling power (Q=1l/min)	kW	0,92
Total liquid content	l	5,0
Max. pressure	Bar	3,5
Max. flow	l/min	8
Input voltage U_1 [V/Hz]	V/Hz	230/1~50
Input current I_1 [A]	A	1,3
Protection		IP 23 S
Weight	kg	22,8
Dimensions (w x l x h)	mm	240 x 660 x 310
Standards		EN 60974-2

Caution





Due to the size of installed power can be for connecting device to public distribution network necessary the agreement from distribution establishment.

5. EQUIPMENT

CONTENT OF DELIVERY

Item No.	Description	Picture
5.0526	PEGAS 320 AC/DC PULSE	
5.0525	PEGAS 400 AC/DC PULSE	
5847	Set Connectors ST 12 PIN	

ACCESSORIES TO ORDER

Item No.	Description	Picture
VM0321-2	Hose Gas 3m Pegas quick connector G1/4	
VM0025	Earthing cable 3 m 500 A 70 mm ²	
VM0185	Cable with E holder 3 m 400 A 35-70	
18SCSL4ST	Torch PARKER SGT 18SC 4m 35-50 ST	
18SCSL8ST	Torch PARKER SGT 18SC 8m 35-50 ST	
18SCSL4STUD	Torch PARKER SGT 18SC 4m 35-50 ST UD	
18SCSL8STUD	Torch PARKER SGT 18SC 8m 35-50 ST UD	

6008	Pressure Reducer FIXICONTROL Ar 2 manometers GCE	
5.0174ST	Foot Pedal Remote CTRL 3 m PEGAS incl. Connector ST	
S7SUN9B	Welding Helmet S9B Shooting Blue Shark	
5.0529	CS Cooling Unit PEGAS 320 a 400 AC/DC	
4600	Refrigerant for welding torches ACL-10 5L	

6. OPERATOR CONTROLS

MAIN PARTS

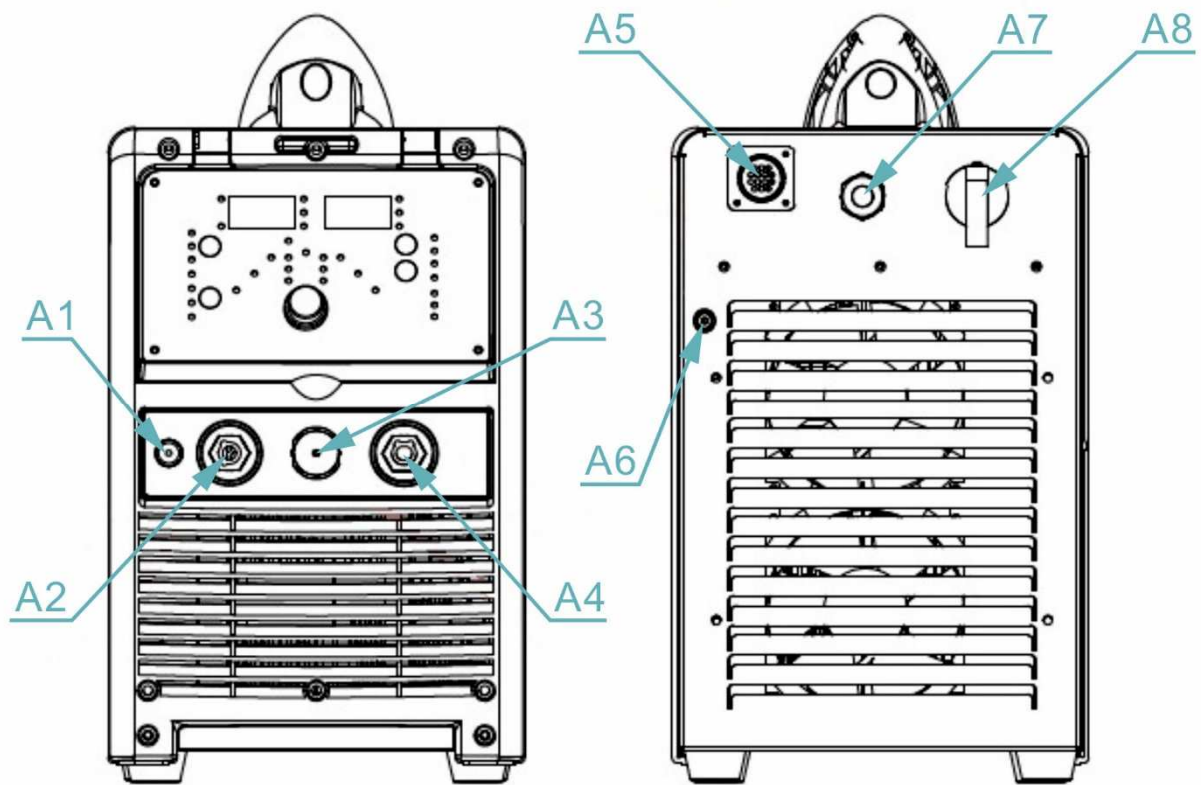

Fig. 1 – Main parts

Pos.	Description
A1	TIG connector of gas connection
A2	Quick connector (-)
A3	TIG connector of remote control
A4	Quick connector (+)
A5	Connector of cooling unit connection
A6	Connector of gas connection
A7	Mains cable
A8	Main switch

COOLING UNIT

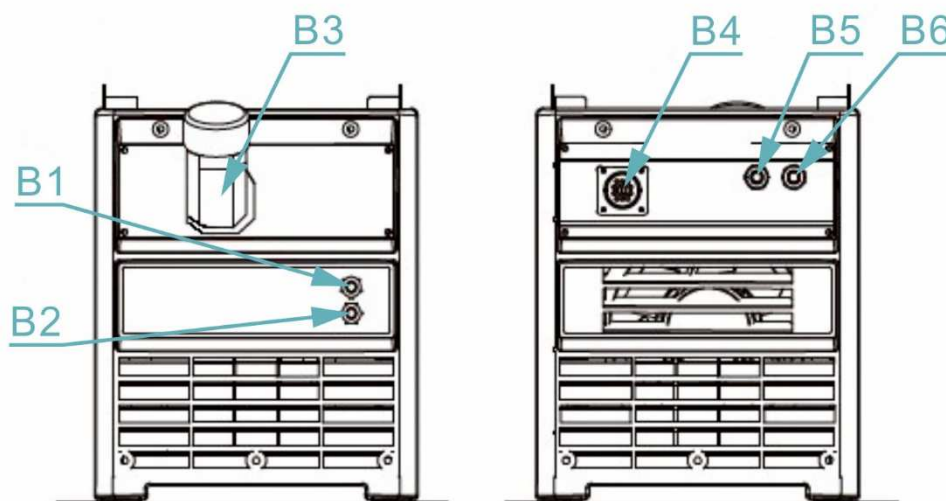

Fig. 2 – Cooling unit

Pos.	Description
B1	Quick connector (blue)
B2	Quick connector (red)
B3	Tank for cooling liquid
B4	Connector for connecting the cooling unit to the machine
B5	Quick connector (blue)
B6	Quick connector (red)

1. In this ALFA IN machine is the pump seal specially designed for the cooling liquid ACL-10 (pink colour, ordering number: 4600, 5 l canister. Working area – ambient temperature -10 °C to +40 °C).
2. When using other liquid, it may cause the leakage of the cooling circuit. The manufacturer's warranty is not applicable to defects in the cooling circuit when using liquids other than ACL-10.
3. We recommend replacing the liquid completely in one to three years. The liquid must not be mixed with any other kind of liquid. The process of replacing the liquid can be found on the internet address https://www.alfain.eu/static/_dokumenty/1/2/9/7/1/1/Vymena-chladici-kapaliny1-navod-CZ.pdf
4. Liquid level in the tank must be between maximum and minimum. (The maximum is the upper limit of the watermark and the minimum is half the scale on the watermark after complete filling of the water circuit of the machine.)

If an error message “E11” - **Lack of liquid** lights up during operation, turn off the main switch and check the liquid level on the watermark. After turning on the machine perform the cooling unit test. If the error recurs, the cause of the fault must be determined.

- Liquid ACL-10 is not poisonous. However, due to its operation in the pump, the replaced liquid dispose of as hazardous waste. Do not burden the environment. In the worst case, take it to a collection yard in the original canister. You can find the safety data sheet on the link https://www.alfain.eu/static/_dokumenty/1/3/0/5/4/7/Safety-data-sheet-ACL-10.pdf



- Note: When connecting a gas-cooled torch, it is necessary to interconnect the quick connectors with water hose of the hydraulic circuit. If this condition is not met, it may result in damage to the pump.

OPERATING PANEL

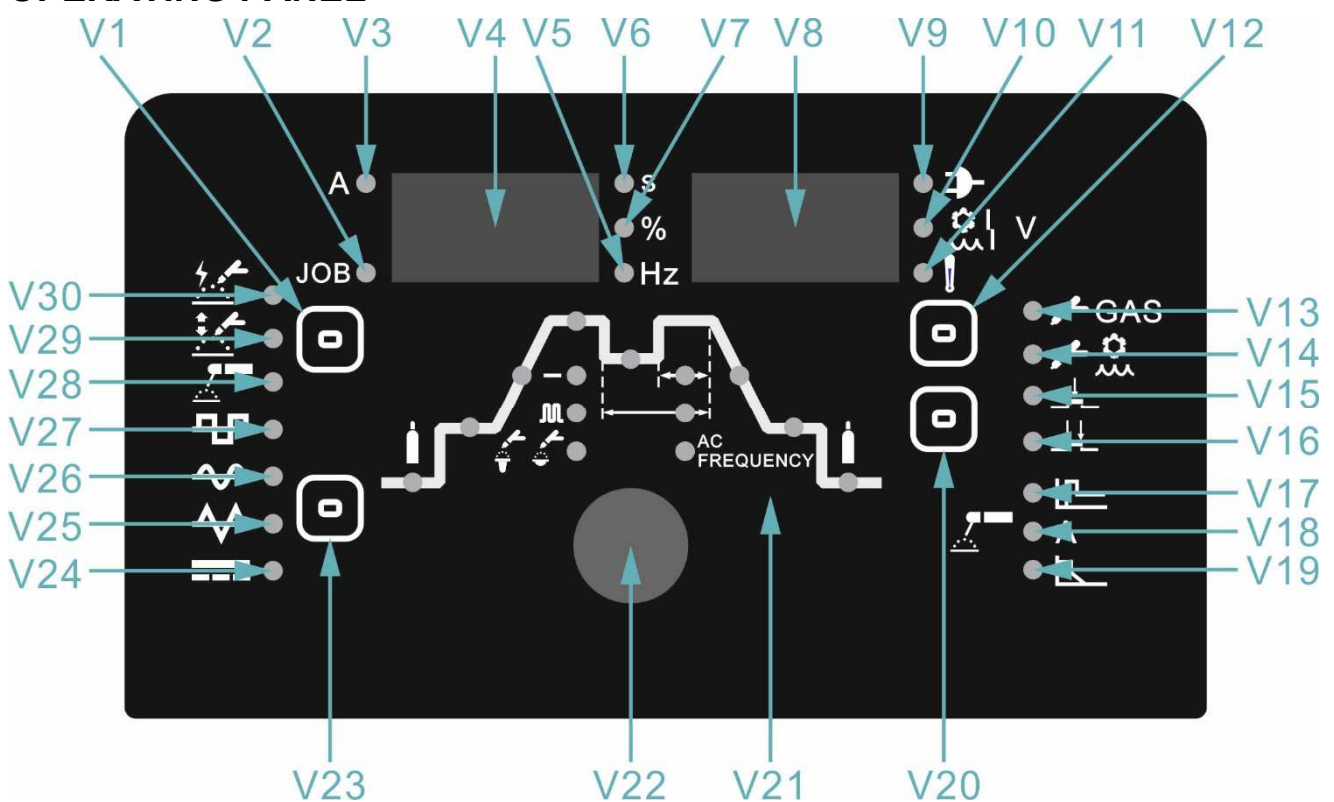

Fig. 3 – Operating panel

Pos.	Description
V1	Button of welding method selection (MMA/TIG)

V2	LED JOB
V3	LED A, values on the display V4 are in A
V4	Left display
V5	LED Hz, values on the display V4 are in Hz
V6	LED s, values on the display V4 are in s
V7	LED %, values on the display V4 are in %
V8	Right display
V9	LED of turning on the machine
V10	LED of cooling unit error
V11	LED ALARM
V12	Button of cooling selection – air/water
V13	LED of gascooled torch
V14	LED of watercooled torch
V15	LED 2T (2 stroke)
V16	LED 4T (4 stroke)
V17	LED HOT START for MMA
V18	LED of welding current setting for MMA
V19	LED ARC FORCE for MMA
V20	Button of selection 2T/4T
V21	TIG parameters curve
V22	Encoder
V23	Button of welding current mode selection (AC/DC)
V24	LED DC wave
V25	LED AC triangle wave
V26	LED AC sine wave
V27	LED AC advanced square wave
V28	LED MMA
V29	LED TIG LIFT
V30	LED TIG HF

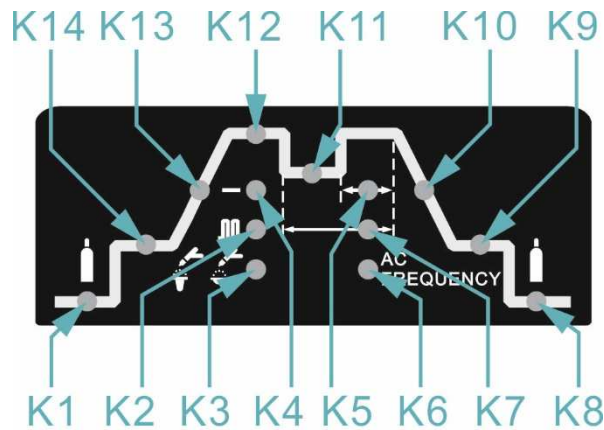

Fig. 4 – Parameters curve

Pos.	Description	
K1	LED pre gas	0,1 – 2,0 s
K2	LED pulsed mode is ON	
K3	LED AC balance	-5 – +5
K4	LED pulsed mode is OFF	
K5	LED pulse width Only available when the pulsed mode is selected.	5 – 95 %
K6	LED AC frequency	50 – 250 Hz
K7	LED pulse frequency Only available when the pulsed mode is selected.	0,5 – 999 Hz
K8	LED post gas	0 – 10 s
K9	LED final current Only available in 4T.	10 – 320A/400A
K10	LED down slope	0 – 10 s
K11	LED second current - BILEVEL	10 – 320A/400A
K12	LED main welding current	10 – 320A/400A
K13	LED up slope	0 – 10 s
K14	LED starting current	10 – 320A/400A

Caution After turning on the machine and changing the data by means of the encoder **V22**, the displays **V4** and **V8** flash once after approx. 3 s, the machine saves the changed data with this signal.

7. GETTING STARTED

Getting started must be consistent with technical data and conditions of use.

GETTING STARTED MMA – COATED ELECTRODE

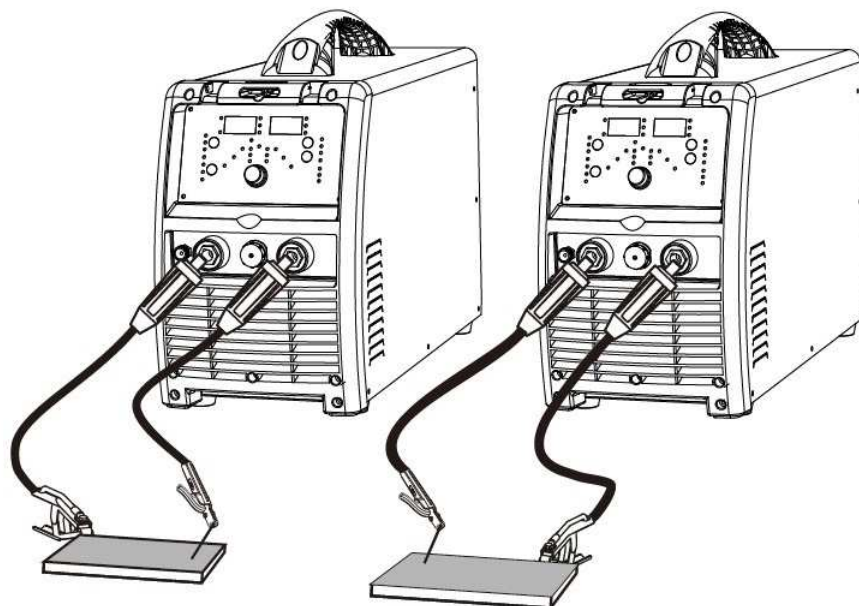

Fig. 5 – Getting started MMA

1. Insert the mains plug into a suitable 3x400 V mains socket, 50-60 Hz. The supply fuses or circuit breaker should correspond to the technical data stated in this manual.
2. Connect the welding cables to the quick connectors (+) **A4** and (-) **A2** according the instruction on the electrodes packing.
3. Switch the machine on by the main switch **A8**.
4. By means of the button **V1** select MMA method, LED **V28** will shine.
5. By means of the button **V23** select the welding current mode (AC or DC)
6. By means of the encoder **V22** set the welding current. The values will be showed on the display **V4**.
7. Press and then rotate the encoder **V22** to adjusting the level of HOT START (increase of current during arc ignition time), ARC FORCE (an automatic increase of the welding current in case the electrode touches the welding piece) and Arc Length.
8. Then switch to the MMA mode by means of the encoder **V22**, LED **V18** must shine and LEDs **V7** and **V11** may not illuminate.
9. Connect the earthing clamp to the weldment.
10. Insert into the electrode holder the appropriate electrode and you can start welding.

👉 NOTE 👉 Prevent touching the electrode any metal material for in this mode the quick connectors **A4** and **A2** are under current.
Insert the coated electrode into the electrode holder, connect the clamps of the

ground cable to the welding piece and you may start welding.

TABLE OF ELECTRODE CONSUMPTION DURING WELDING

Electrode diameter [mm]	Range of welding current [A]	Total electrode length [mm]	Weight of boiled electrode without slag [g]	Boiled electrode time [s]	Weight of boiled electrode without slag per 1 second [g/s]
1,6	30 - 55	300	4	35	0,11
2,5	70 - 110	350	11	49	0,22
3,2	90 - 140	350	19	60	0,32
4,0	120 - 190	450	39	88	0,44

GETTING STARTED TIG

TIG MODE WITH WATERCOOLED TORCH

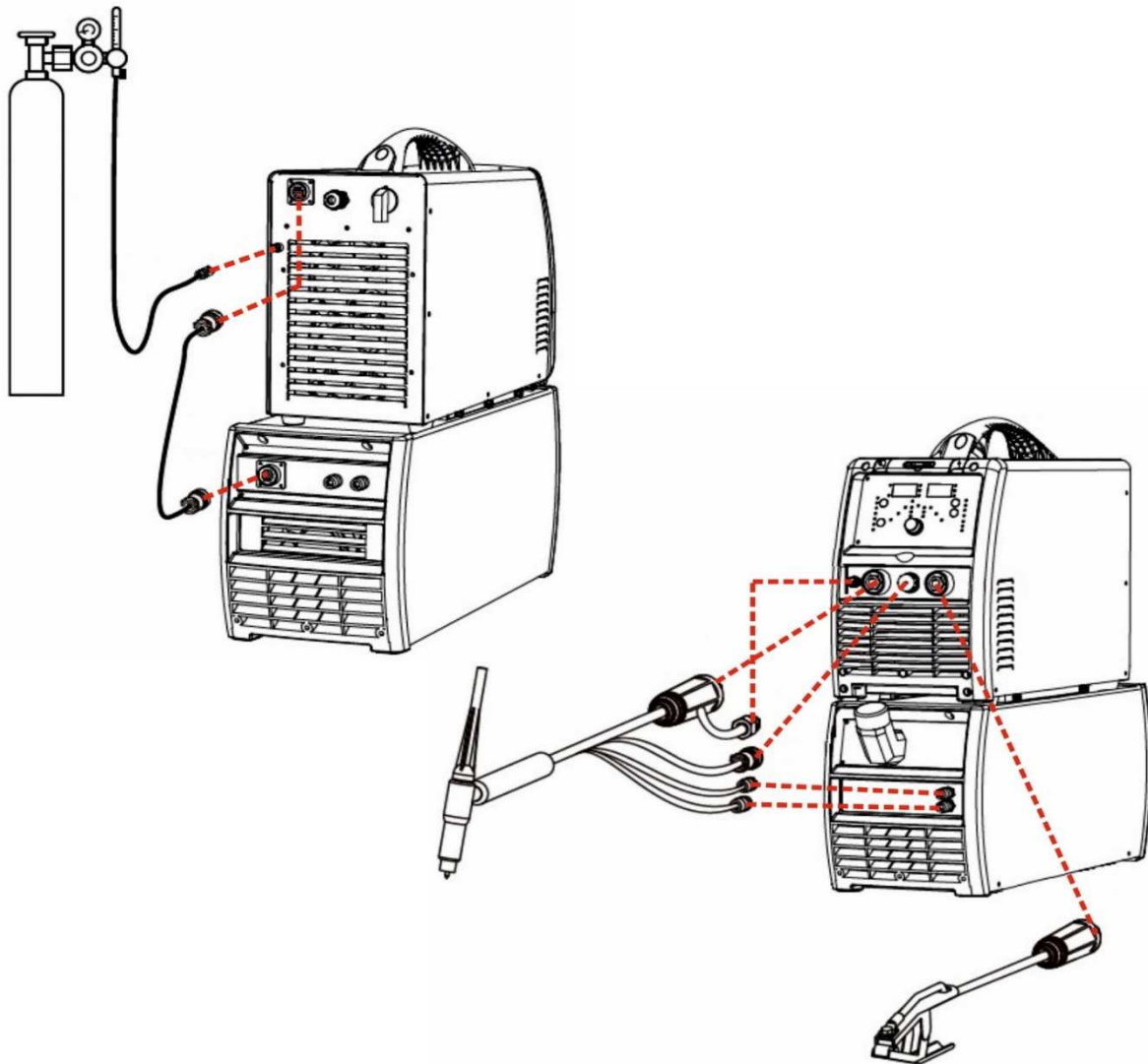

Fig. 6 – Getting started TIG with watercooled torch

1. Insert the mains plug into a suitable 3x400 V mains socket, 50-60 Hz.
2. Connect the watercooled torch to the front panel of the welding machine and to the front panel of the cooling unit, see fig. above.
3. Connect the earthing clamp to the quick connector (+) **A4**.
4. Connect the cooling unit to the welding machine (if it is not already connected) according to fig. above.
5. Connect the gas hose to the gas cylinder connector on the gas bottle and to the connector **A6** on the rear panel.
6. Switch the machine on by the main switch **A8**.
7. By means of the button **V1** select method TIG LIFT or TIG HF, LED **V29** or **V30** will shine.
8. Switch the cooling unit on by the switch on the rear panel of the cooling unit.
9. By means of the button **V12** select the water cooling of the torch. LED **V14** will shine.
10. By means of the torch button activate the gas test and set the required flow of the protective gas.
11. By means of the button **V20** select TIG 2T or 4T. The appropriate LED **V15**, **T16** will shine.
12. By means of the button **V23** select the welding current mode (AC or DC). Method must have the appropriate tungsten electrode and grinding method. The appropriate LEDs **V24**, **V25**, **V26**, **V27** will shine.
13. By means of the encoder **V22** set the required welding current.
14. The others parameters (TIG parameters curve) is possible modify by means of the encoder **V22**. The appropriate LED will shine. The required parameter is automatically saved, when you go over to the next parameter or after 3 s of the encoder inactivity. For more information see COOLING UNIT

Fig. 2 – Cooling unit

Pos.	Description
B1	Quick connector (blue)
B2	Quick connector (red)
B3	Tank for cooling liquid
B4	Connector for connecting the cooling unit to the machine
B5	Quick connector (blue)
B6	Quick connector (red)

7. In this ALFA IN machine is the pump seal specially designed for the cooling liquid ACL-10 (pink colour, ordering number: 4600, 5 l canister. Working area – ambient temperature -10 °C to +40 °C).

8. When using other liquid, it may cause the leakage of the cooling circuit. The manufacturer's warranty is not applicable to defects in the cooling circuit when using liquids other than ACL-10.
9. We recommend replacing the liquid completely in one to three years. The liquid must not be mixed with any other kind of liquid. The process of replacing the liquid can be found on the internet address https://www.alfain.eu/static/_dokumenty/1/2/9/7/1/1/Vymena-chladici-kapaliny1-navod-CZ.pdf
10. Liquid level in the tank must be between maximum and minimum. (The maximum is the upper limit of the watermark and the minimum is half the scale on the watermark after complete filling of the water circuit of the machine.)

If an error message “**E11**” - **Lack of liquid** lights up during operation, turn off the main switch and check the liquid level on the watermark. After turning on the machine perform the cooling unit test. If the error recurs, the cause of the fault must be determined.

11. Liquid ACL-10 is not poisonous. However, due to its operation in the pump, the replaced liquid dispose of as hazardous waste. Do not burden the environment. In the worst case, take it to a collection yard in the original canister. You can find the safety data sheet on the link https://www.alfain.eu/static/_dokumenty/1/3/0/5/4/7/Safety-data-sheet-ACL-10.pdf
12. Note: When connecting a gas-cooled torch, it is necessary to interconnect the quick connectors with water hose of the hydraulic circuit. If this condition is not met, it may result in damage to the pump.
15. OPERATING PANEL.
16. You can start welding.

TIG MODE WITH GASCOOLED TORCH

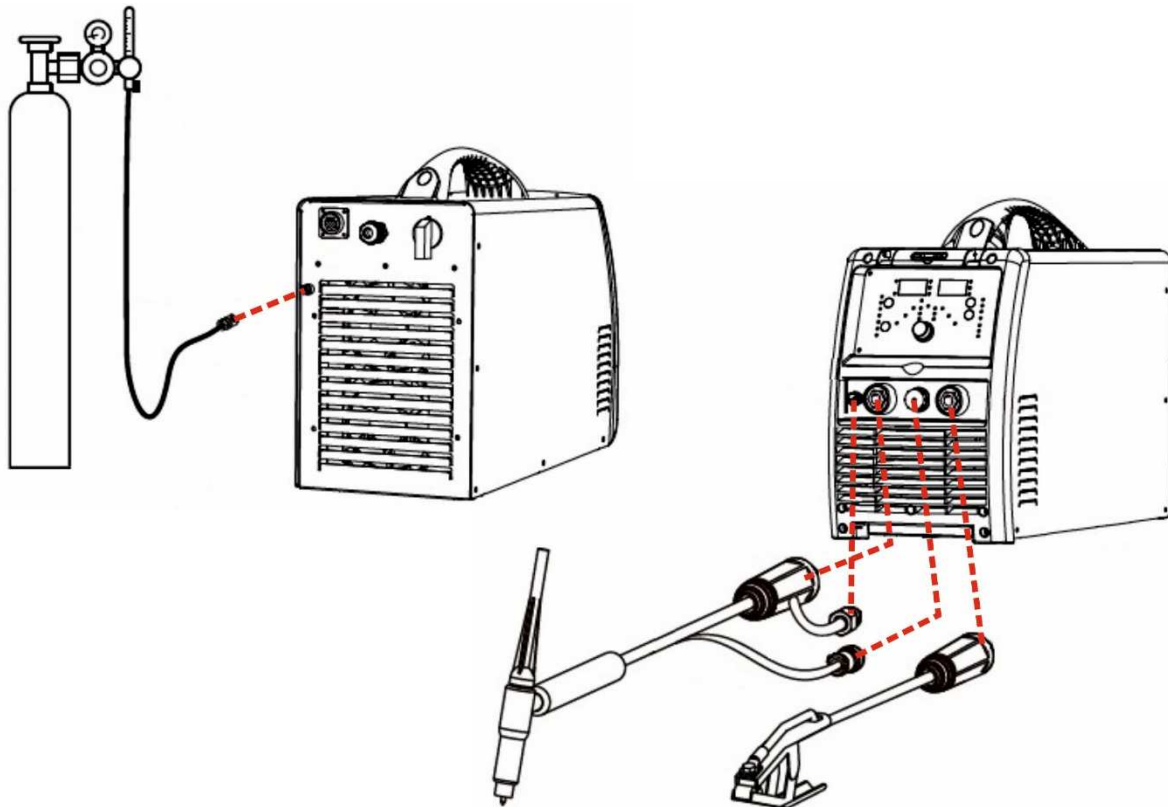

Fig. 7 – Getting started TIG with gascooled torch

1. Insert the mains plug into a suitable 3x400 V mains socket, 50-60 Hz.
2. Connect the gascooled torch to the front panel, see fig. above.
3. Connect the earthing clamp to the quick connector (+) **A4**.
4. Connect the gas hose to the gas cylinder connector on the gas bottle and to the connector **A6** on the rear panel.
5. Switch the machine on by the main switch **A8**.
6. By means of the button **V1** select method TIG LIFT or TIG HF, LED **V29** or **V30** will shine.
7. By means of the button **V12** select the gas cooling of the torch. LED **V13** will shine.
8. By means of the torch button activate the gas test and set the required flow of the protective gas.
9. By means of the button **V20** select TIG 2T or 4T. The appropriate LED **V15**, **V16** will shine.
10. By means of the button **V23** select the welding current mode (AC or DC). Method must have the appropriate tungsten electrode and grinding method. The appropriate LEDs **V24**, **V25**, **V26**, **V27** will shine.
11. By means of the encoder **V22** set the required welding current.
12. The others parameters (TIG parameters curve) is possible modify by means of the encoder **V22**. The appropriate LED will shine. The required parameter is automatically saved, when you go over to the next parameter

or after 3 s of the encoder inactivity. For more information see COOLING UNIT

Fig. 2 – Cooling unit

Pos.	Description
B1	Quick connector (blue)
B2	Quick connector (red)
B3	Tank for cooling liquid
B4	Connector for connecting the cooling unit to the machine
B5	Quick connector (blue)
B6	Quick connector (red)

13. In this ALFA IN machine is the pump seal specially designed for the cooling liquid ACL-10 (pink colour, ordering number: 4600, 5 l canister. Working area – ambient temperature -10 °C to +40 °C).
14. When using other liquid, it may cause the leakage of the cooling circuit. The manufacturer's warranty is not applicable to defects in the cooling circuit when using liquids other than ACL-10.
15. We recommend replacing the liquid completely in one to three years. The liquid must not be mixed with any other kind of liquid. The process of replacing the liquid can be found on the internet address https://www.alfain.eu/static/_dokumenty/1/2/9/7/1/1/Vymena-chladici-kapaliny1-navod-CZ.pdf
16. Liquid level in the tank must be between maximum and minimum. (The maximum is the upper limit of the watermark and the minimum is half the scale on the watermark after complete filling of the water circuit of the machine.)

If an error message “**E11**” - **Lack of liquid** lights up during operation, turn off the main switch and check the liquid level on the watermark. After turning on the machine perform the cooling unit test. If the error recurs, the cause of the fault must be determined.
17. Liquid ACL-10 is not poisonous. However, due to its operation in the pump, the replaced liquid dispose of as hazardous waste. Do not burden the environment. In the worst case, take it to a collection yard in the original canister. You can find the safety data sheet on the link https://www.alfain.eu/static/_dokumenty/1/3/0/5/4/7/Safety-data-sheet-ACL-10.pdf

18. Note: When connecting a gas-cooled torch, it is necessary to interconnect the quick connectors with water hose of the hydraulic circuit. If this condition is not met, it may result in damage to the pump.

13. OPERATING PANEL.

14. You can start welding.

⚠ Caution ⚠ Make sure, that in gascooled torch welding method is the cooling unit turned off. At turning of the cooling unit on and at choice of the gascooled torch can happened the pump damage.

BALANCE FUNCTION IN AC MODE

Function allows to set the ratio between the cleaning effect (plus part of the wave) and the penetration (minus part of the wave).

Shape of the current curve		
BALANCE	Value 15%	Value 50%
Cleaning effect	Smallest	Biggest
Penetration	Shallow	Deep
Level of wear of the tungsten electrode	Smaller	Bigger

TABLE OF CONSUMPTION DURING TIG WELDING

Wolfram electrode diameter [mm]	Argon flow [l/min]
	Steel / stainless steel
0,5	3 – 4
1,0	3 – 5
1,6	4 – 6
2,4	5 – 7
3,2	5 – 9

REMOTE CONTROL

PEGAS 320-400 AC/DC PULSE can work in both of TIG modes with three types of remote control.

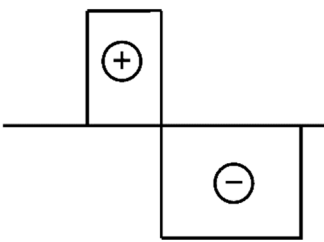
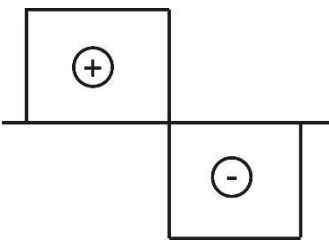
1. TIG torch with UP-DOWN buttons for selecting size of welding current.
2. Additional remote control of welding current size.
3. Foot pedal.

Remote controls are connected with connector **A3**.

Function of the foot pedal

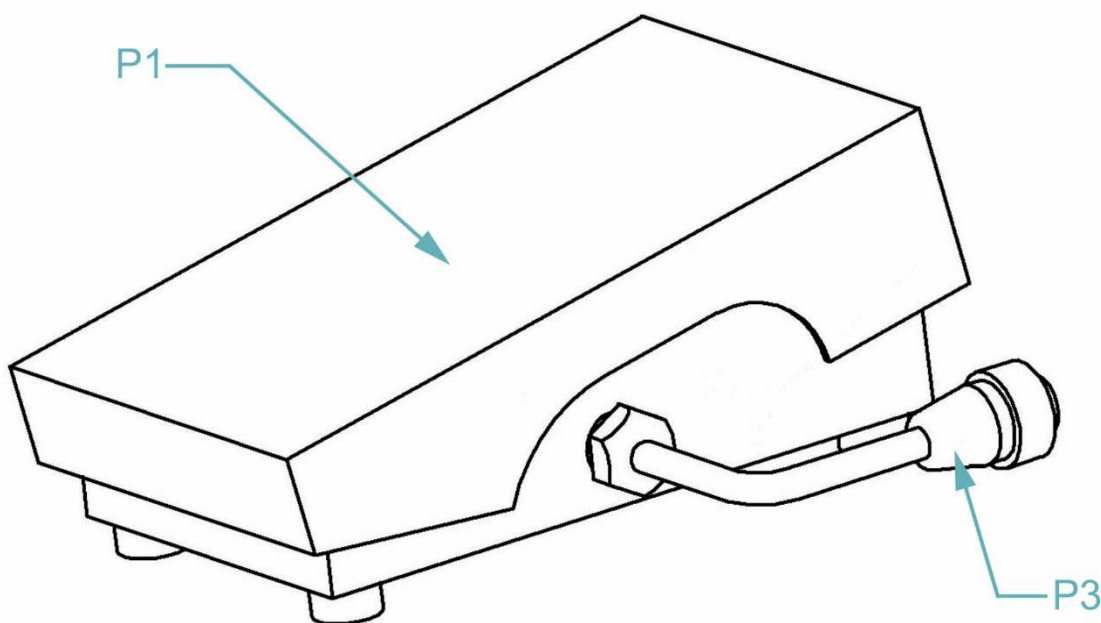

Fig. 8 – Foot pedal remote control

Pos.	Description
P1	Stepping surface
P3	Connector of the remote control (connect to matching connector A3 on the front panel)

1. When you connect the connector **P3** to matching connector **A3** on the front panel, the function setting the current from the torch will be automatically blocked.
2. By means of the encoder **V22** set maximal required value of the current.
3. Set the machine to the mode **2T**.
4. By pressing the stepping surface **P1** down, you start the welding process. The value of the welding current depends on the level of pressing the stepping surface. To reach the maximal current, set by the encoder **V22**, requires to gently pressing to the lowest position of the stepping surface **P1**. The set current will be displayed on the current display **V4** see fig. n.

3.

5. The welding process ends after releasing the stepping surface **P1**.

8. TWO STROKE AND FOUR STROKE IN TIG MODE

TWO STROKE – 2T

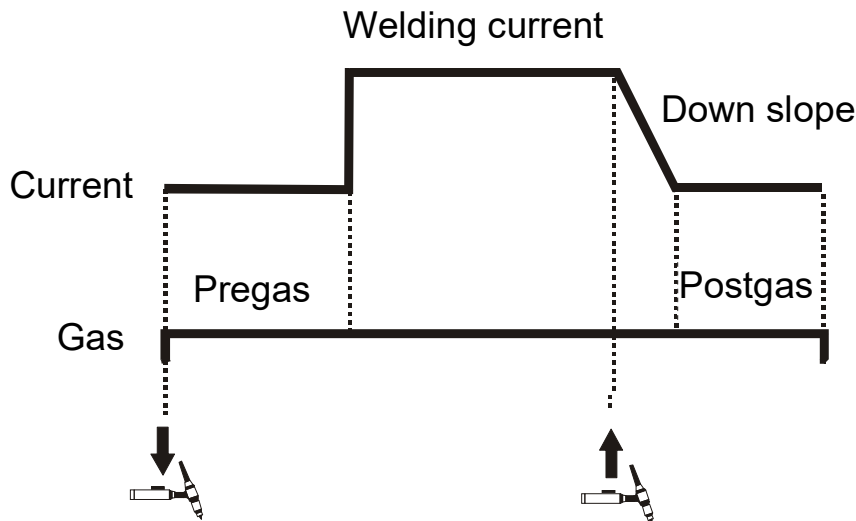

FOUR STROKE – 4T

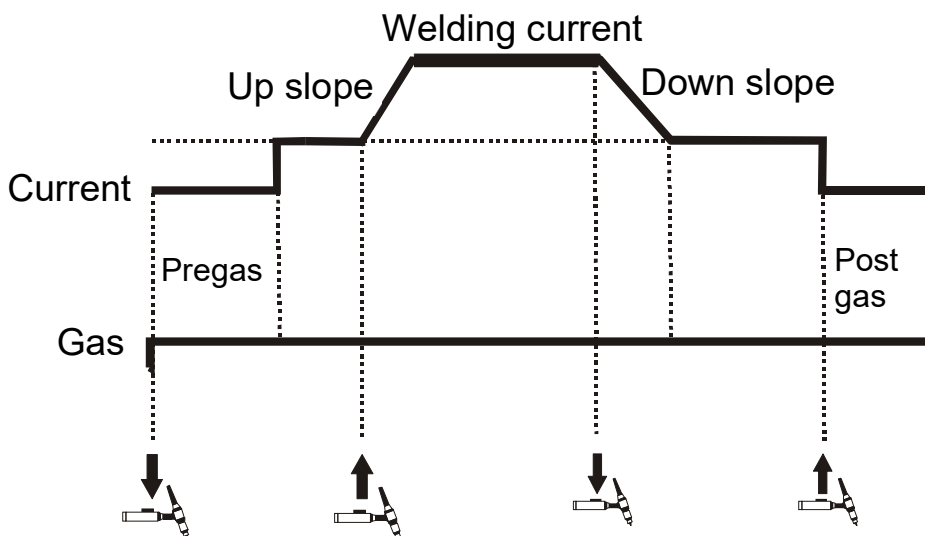

BILEVEL – SECOND WELDING CURRENT

When the machine is in 4T mode, there is always active the BILEVEL function. The value of the second current is automatically set to 50% of the pre-set value of the main welding current. To enter the second welding current press the torch button for a short time and release it. To get back to the main welding current press the torch button for a short time and release it.

9. JOBS

JOBs are available only in TIG method. Before manipulation with JOBs is necessary to select TIG method by means of the button **V29** (TIG LIFT) or **V30** (TIG HF).

The welding machine has a choice from 9 JOBs.

HOW TO LOAD THE SAVED JOB

1. By long pressing the encoder **V22** enter into the JOBs menu. LED **V2** will shine. The left display **V4** will show **Job** and the right display **V8** will show JOB's number (1-9).
2. Rotate the encoder **V22** to selection of required JOB's number.
3. Press the encoder **V22** to confirm the selected JOB. Then you get back to the parameter setting.
4. Note: If you will be in JOBs menu and if you don't select any JOB within 10 s, you automatically get back to the parameters setting without any changes.

HOW TO SAVED PARAMETERS TO THE JOB

1. By long pressing the encoder **V22** enter into the JOBs menu. LED **V2** will shine. The left display **V4** will show **Job** and the right display **V8** will show JOB's number (1-9).
2. Rotate the encoder **V22** to selection of required JOB, which you want to change (for example JOB 1).
3. Confirm selected JOB by pressing the encoder **V22**. Then you get back to the parameters setting.
4. Parameters, which you want to save like JOB 1, set by means of the encoder **V22**. (By short pressing the encoder **V22** switch between particular parameters of the curve.)
5. As soon as you will have saved all parameters, then by long pressing the encoder **V22** get into the JOBs menu. The left display **V4** will show Job and the right display **V8** will show number 1.
6. Your parameters selection confirm by pressing the button of welding method selection **V1**. Then short press the encoder **V22** to exit from the JOBs menu and for return to the parameters setting.

HOW TO DELETE SAVED PARAMETERS FROM THE JOB



It is not possible to delete parameters from the JOB, they can be only replaced by new parameters. To save new parameters, see the chapter HOW TO SAVED PARAMETERS TO THE JOB above.

10. RESET



The factory reset perform by simultaneously pressing the encoder **V22** and the button of welding method selection **V1** for at least 5 s (keep pressed, until the left display **V4** will not show **rSt**).

11. ROUTINE MAINTANCE & INSPECTION

1. The only routine maintenance required for the PEGAS range of machines is a thorough cleaning and inspection, with the frequency depending on the usage and the operating environment.

 **WARNING**  Disconnect the PEGAS from the mains supply voltage before disassembling.

2. Special maintenance is not necessary for the control unit parts in the Welder. If these parts are damaged for any reason, replacement is recommended.

 **CAUTION**  Do not blow air into the welder during cleaning. Blowing air into the welder can cause metal particles to interfere with sensitive electronic components and cause damage to the welder.

3. To clean the welder, disconnect it from the mains supply voltage then open the enclosure and use a vacuum cleaner to remove any accumulated dirt and dust. The welder should also be wiped clean. If necessary, solvents that are recommended for cleaning electrical apparatus may be used.
4. Troubleshooting and repairing of PEGAS welding equipment should only be carried out only by suitably qualified or competent person.
5. A 'competent person' must be a person who has acquired through training, qualification or experience, or a combination of them, the knowledge and skills enabling that person to safely carry out a risk assessment and repairs to the electrical equipment in question.
6. The person carrying out the servicing needs and repairs must know what to look at, what to look for and what to do.

12. STATEMENT OF WARRANTY

1. In accordance with the warranty periods stated below, ALFA IN guarantees the proposed product to be free from defects in material or workmanship when operated in accordance with the written instructions as defined in this operating manual.
2. ALFA IN welding products are manufactured for use by commercial and industrial users and trained personnel with experience in the use and maintenance of electrical welding and cutting equipment.
3. ALFA IN will repair or replace, at its discretion, any warranted parts or components that fail due to defects in material or workmanship within the warranty period. The warranty period begins on the date of sale to the end user.
4. If warranty is being sought, please contact your ALFA IN product supplier for the warranty repair procedure.

5. ALFA IN warranty will not apply to:
 - a. Equipment that has been modified by any other party other than ALFA IN's own service personnel or with prior written consent obtained from ALFA IN Service Department.
 - b. Equipment that has been used beyond the specifications established in the operating manual.
 - c. Installation not in accordance with the installation/operating manual.
 - d. Any product that has been subjected to abuse, misuse, negligence or accident.
 - e. Failure to clean and maintain (including lack of lubrication, maintenance and protection), the machine as set forth in the operating, installation or service manual.
 6. Within this operating manual are details regarding the maintenance necessary to ensure trouble free operation.
- 🖐️NOTE 🖐️ Warranty repairs must be performed by either an ALFA IN Service Centre, an ALFA IN distributor or an Authorised Service Agent approved by the company ALFA IN.
7. As a warranty list serves proof of purchase (invoice) on which is the serial number of the machine, eventually a warranty list on the last page of this manual.
 8. The manufacturer's warranty is not applicable to defects in the cooling circuit when using liquids other than ACL-10.

13. DISPOSAL



Only for EU countries. Do not dispose of electric tools together with household waste material.

■ In accordance with European Council Directive 2002/96/EC on electrical and electronic equipment waste and its implementation in accordance with national law, electric tools that have reached the end of their service life must be collected separately and returned to an environmentally compatible recycling facility.

14. WARRANTY LIST

As a warranty list serves proof of purchase (invoice) on which is the serial number of the machine, eventually a warranty list below, which is filled in by an authorized dealer.

Serial number:	
Day, month (written in words) and year of sale:	
Stamp and dealer signature:	