

**WELDING MACHINE**

**PEGAS 250 E CEL** *smart*

**OPERATING MANUAL**

**CONTENT:**

1. INTRODUCTION.....	- 3 -
2. SAFETY PRECAUTIONS .....	- 4 -
3. OPERATING CONDITIONS .....	- 5 -
4. TECHNICAL DATA .....	- 6 -
5. EQUIPMENT .....	- 7 -
6. OPERATOR CONTROLS .....	- 8 -
7. GETTING STARTED .....	- 10 -
8. ROUTINE MAINTENANCE & INSPECTION .....	- 12 -
9. STATEMENT OF WARRANTY.....	- 13 -
10. DISPOSAL .....	- 13 -
11. WARRANTY LIST .....	- 14 -

# 1. INTRODUCTION

Dear consumer,

Company ALFA IN a.s. thanks you for buying our product and believe that you will be satisfied with our machine.

Welding inverter PEGAS 250 E CEL Smart is designed for professional welding in MMA method (coated electrode) and in TIG method with function Lift Arc. PEGAS 250 E CEL Smart also welds with cellulosic electrodes.

Welding machine may be operated only by trained persons and only in the technical provisions. Company ALFA IN a.s. accept no responsibility for damage caused by improper use. Before commissioning please read carefully this manual.

The machine complies with the appropriate CE mark.

For maintenance and repairs, use only original spare parts. There is of course a complex of our services.

We reserve the law of adjustments and changes in case of printing errors, change of technical paramaters, accessories etc. without previous notice. These changes may not be reflected in the manuals for use in paper or electronic form.



## **2. SAFETY PRECAUTIONS**

### **PERSONAL PROTECTION**



1. For safety reasons, it is necessary to use welding gloves during welding. These gloves will protect you before intervention of electric current (open circuit voltage). It protects you against thermal radiation and splashing drops of hot metal too. Wear sturdy isolated shoes. Do not wear open shoes, because drops of hot metal can cause burns.
2. Do not look into the welding arc without eye and face protection. Always use good quality welding helmet with intact protective filter.
3. The persons appearing in the vicinity of the welding must be informed of the danger and must be equipped with protective equipment.
4. During welding, especially in small spaces, it is necessary to ensure an adequate supply of fresh air, because during welding, harmful fumes arise.
5. In tanks of gas, oil, fuel, etc., (even empty ones) do not make welding, because there is a chance of explosion.
6. In areas with chance of explosion special provisions are applied.
7. Welding machines that are subjected to great exertion must comply with specific security requirements. These include the rail pressure of the vessel etc. These connections may only be carried out by competently trained welders with the necessary permissions.

### **SAFETY REGULATIONS**

1. Before starting work with welding machine it is necessary to get familiar with applicable provisions of standards.
2. The welder must use protective equipment.
3. Before working on the electrical part, removing the cover or cleaning it is necessary to disconnect the device from the network.

### 3. OPERATING CONDITIONS

1. Putting the machine into operation can be performed only by trained personnel and only within the technical provisions. The manufacturer is not liable for damages resulting from improper use or handling. For maintenance and repair, use only original spare parts from ALFA IN.
2. Device complies with IEC 61000-3-12.
3. The welding machine is tested according to the degree of protection IP 23S, which provides protection against the intrusion of solid bodies with a diameter greater than 12 mm and protection against ingress of water, falling on the machine in a vertical direction or max degree of 60°.
4. Working ambient temperature between -10 and +40 °C.
5. Relative humidity below 90% at +20 °C.
6. Up to 3000 m altitude.
7. The machine must be positioned so that cooling air can enter and leave through cooling vents with no problem. It is necessary to ensure that there are no mechanical equipment, especially metal particles (e.g. during grinding) drawn into the machine.
8. Cooling is controlled by an electronic temperature automatics.
9. It is necessary for welding machine to undergo a periodic inspection every 6/12 months by an authorized officer according to ČSN 331500 and ČSN 050630 – see Maintenance and service tests.
10. All interventions in the el. equipment as well as repair (removal of the plug, fuse replacement) should be performed by an authorized person.
11. Welding machine is from the factory set at 400V with tolerance range of  $\pm 13\%$ , which allows operation of the device in mains  $\sim 380V$ .
12. With competent mains voltage and input must match the plug.
13. PEGAS is equipped with function HOT START for perfect arc ignition, function ARC-FORCE which ensures stable arc, function ANTI-STICK which prevents the electrode sticking to the weldment and with function VRD for voltage reduction.
14. This machine can also weld in MMA / TIG method with touch ignition (LIFT ARC).

 **Caution**  **Extension cables must not have conductors with a smaller cross section than  $4 \times 2,5 \text{ mm}^2$ . The machine can be operated on a three-phase electric generator 14 kVA (3x400V/50Hz) and more, which has ensured voltage stabilization  $\pm 10\%$ . Generators with lower power can damage the machine.**

15. It is necessary to protect the machine against:
  - a. Moisture and rain
  - b. Mechanical damage
  - c. Draft and possibly ventilation of neighboring machines
  - d. Excessive overloading – exceeding tech. parameters
  - e. Rough treatment

## ELECTROMAGNETIC COMPATIBILITY

The welding device is in terms of interference designed primarily for industrial areas. It meets the requirements of EN 60974-10 class A and it isn't designed for using in residential areas, where the electrical energy is supplied by public low-voltage power supply network. It can be here potential problems with ensuring of electromagnetic compatibility in this areas, due to interference caused by power lines as well as the radiated interference.

During operation, the device may be the source of interference.

 Caution 

We warn users, that they are responsible for possible interference from welding.

## 4. TECHNICAL DATA

Method		MMA	TIG
Mains voltage	V/Hz	3x400/50-60	
Welding current range	A	10 - 250	10 - 250
Open-circuit voltage $U_{20}$	V	91,0 (21,0) *	21,0
Mains protection	A	16 @	
Max. effective current $I_{1eff}$	A	13,6	9,7
Welding current (DC=100%) $I_2$	A	200	200
Welding current (DC=60%) $I_2$	A	230	230
Welding current (DC=x%) $I_2$	A	45%=250	45%=250
Protection		IP23S	
Standards		EN 60974-1, EN 60974-10 cl. A	
Dimensions (w x l x h)		190 x 455 x 340	
Weight	kg	13,5	

\*) Decreased value – only if the MMA VRD mode is active (for description please see function description on the page 9.

 The machine marked with this symbol can be used for welding in areas with an increased risk of electric shock.

The machine structure is designed so that, in any case, even if the failure rectifier does not exceed the permitted peak value of the open circuit voltage according to EN 60974-1, i.e., 113 V direct current or 68 V alternating.

## 5. EQUIPMENT





### ACCESSORIES TO ORDER

#### WELDING TORCHES

Description	Cooling
SRT 26 V	Gas

**⚠️ Cautin ⚠️** The torch must be selected according to the used current range. The company ALFA IN a.s. is not responsible for welding torches damage due to overload.

#### OTHER ACCESSORIES

Item. No.	Description	Picture
VM0139	Welding Cable Set 2x 3m 35-50 250A	
5.0139ST	Remote CTRL 10 m PEGAS incl. ST	
6008	Ventil red. FIXICONTROL Argon 2 manometry GCE	
S777c.	Welding Helmet Barracuda S777C Black	

## 6. OPERATOR CONTROLS

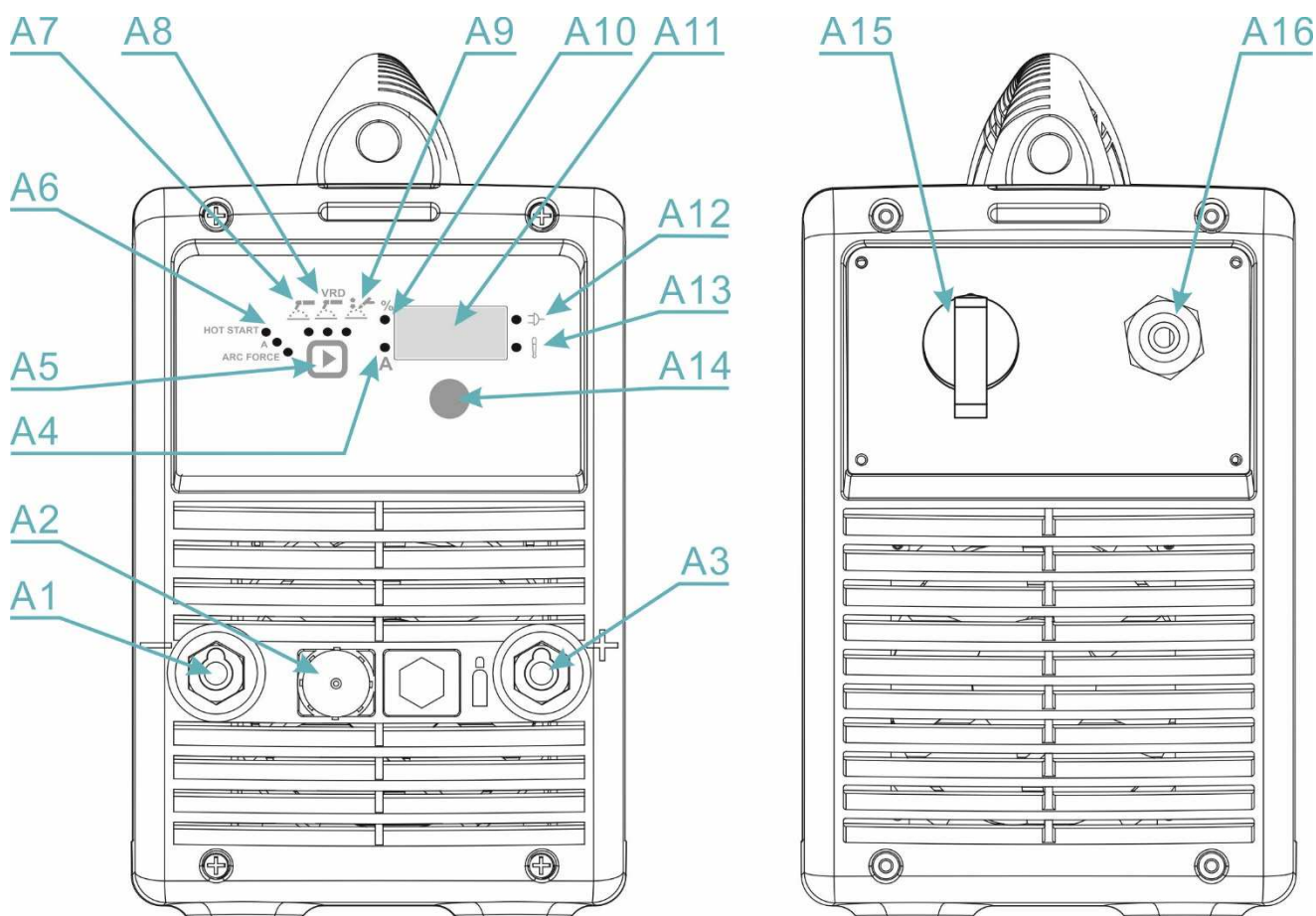





Fig. 1 – Main parts

Pos.	Description
A1	Quick connector (-)
A2	Connector for torch control
A3	Quick connector (+)
A4	LED – values in A
A5	Welding method switch  MMA electrode  MMA VRD  TIG
A6	LED of selected functions (HOT START/A/ARC FORCE)
A7	LED – MMA method is selected
A8	LED – MMA VRD method is selected



A9	LED – TIG method is selected
A10	LED – values in %
A11	Display
A12	LED of turning on the machine
A13	LED overheating (When illuminated leave the machine turned on and wait until the machine cools down.)
A14	Encoder
A15	Main switch
A16	Mains cable

**Overheating of the machine** – LED ALARM lights up and the machine switches to the mode, when is effectively cooled to the operating temperature. Don't use the machine for about 15 minutes. Until the machine reaches the operating temperature, it remains in „cooling mode“ and the machine will only be able to supply reduced welding current.

**HOT START** – Function HOT START is designed for easier arc ignition.

**ARC FORCE** – Function ARC FORCE is the prevention against the unwanted sticking of the electrode to the weldment and against the unwanted arc extinguishing.

ARC FORCE is off – it is used at medium and higher welding currents.

Maximal ARC FORCE - it is used if you weld with low currents (vertically up, over the head, etc.).

Increased ARC FORCE – it is used for easier arc ignition and arc maintaining, for good penetration.

When welding thin sheets, ARC FORCE increases the risk of burning.

**MMA VRD** – Voltage Reduction Device. If this mode is active and when the welding process is finished the VRD immediately reduces the open-circuit voltage to 21 V. Inverters PEGAS 250 E CEL Smart generate the open-circuit voltage 91 V (MMA) and 21 V (TIG), which is safe and is in compliance with the standard EN 60974-1. However, in a certain environment the welder can feel very unpleasant tingling – electrical shocks. If the MMA VRD mode is active, it will not exposure the welders to those unpleasant states.

## 7. GETTING STARTED

Getting started must be consistent with technical data and conditions of use.

### GETTING STARTED MMA – COATED ELECTRODE

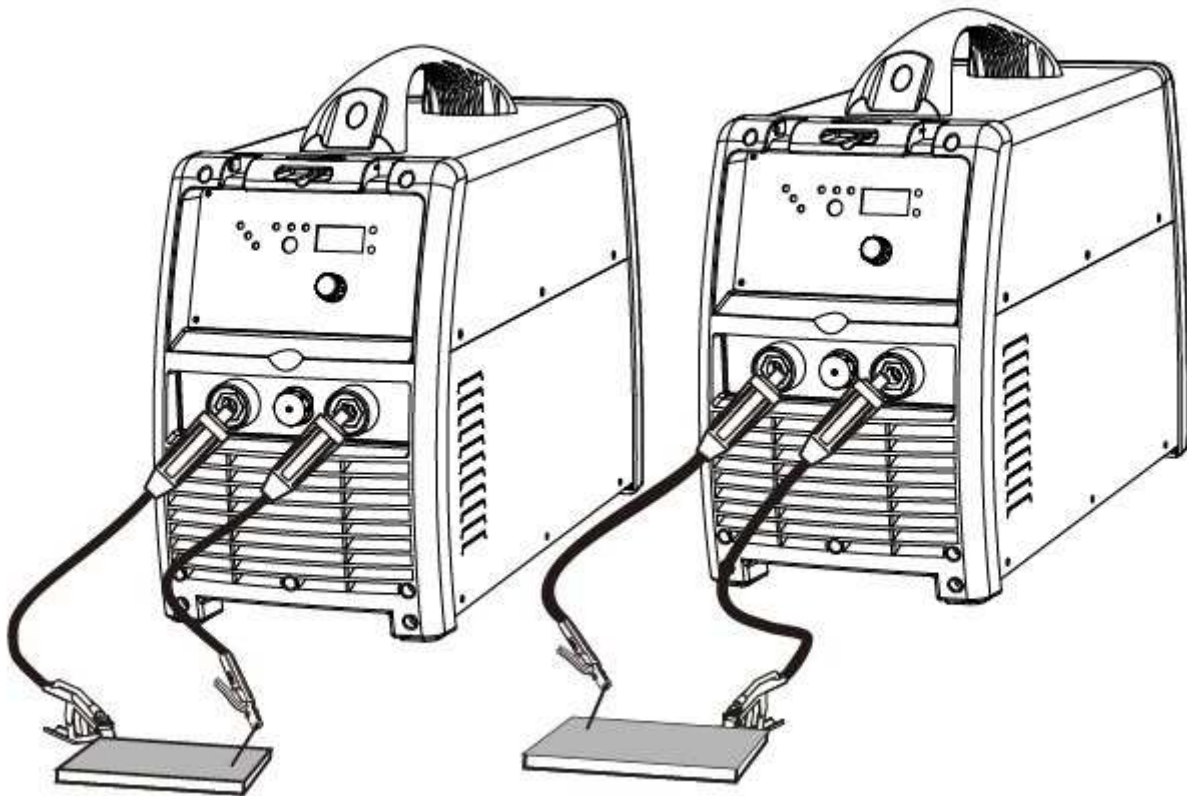





Fig. 2 – Getting started MMA (only illustrative)

1. Insert the mains plug into a suitable 3x400 V mains socket, 50 Hz. The supply fuses or circuit breaker should correspond to the technical data stated in this manual.
2. Switch the main switch **A15** to the position “ON”.
3. Connect the electrode holder to the quick connector (+) **A3** and the earthing cable to the quick connector (-) **A1** according the instruction on the electrodes packing.
4. By means of the switch **A5** switch to the position MMA  or MMA .  
**VRD**
5. By means of the encoder **A14** set the welding current.
6. Press and then rotate the encoder **A14** to adjusting the level of HOT START and ARC FORCE. The appropriate LED **A6** will shine.

 NOTE  Prevent touching the electrode any metal material for in this mode the quick connectors **A3** and **A1** are under current. Insert the coated electrode

into the electrode holder, connect the clamps of the ground cable to the welding piece and you may start welding.

### TABLE OF ELECTRODE CONSUMPTION DURING WELDING

Electrode diameter [mm]	Range of welding current [A]	Total electrode length [mm]	Weight of boiled electrode without slag [g]	Boiled electrode time [s]	Weight of boiled electrode without slag per 1 second [g/s]
1,6	30 - 55	300	4	35	0,11
2,5	70 - 110	350	11	49	0,22
3,2	90 - 140	350	19	60	0,32
4,0	120 - 190	450	39	88	0,44

### GETTING STARTED TIG

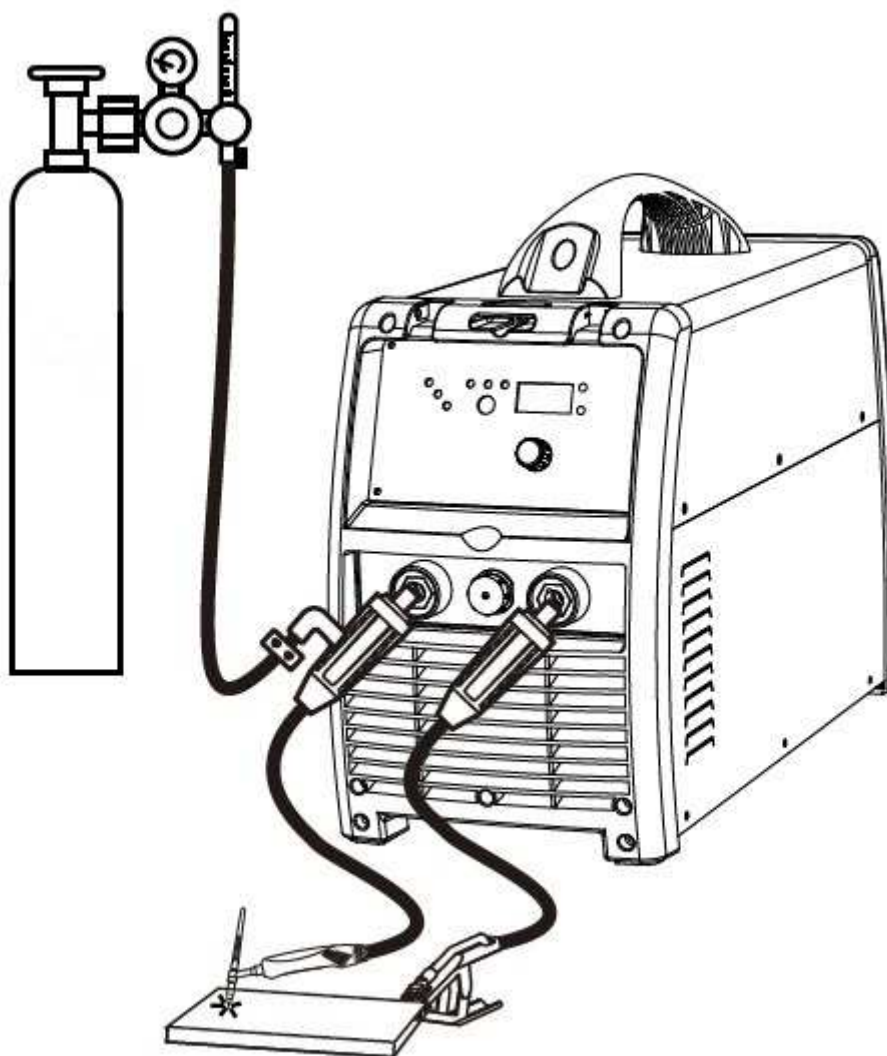

Fig. 3 – Getting started TIG (only illustrative)

1. Insert the mains plug into a suitable 3x400 V mains socket, 50 Hz. The supply fuses or circuit breaker should correspond to the technical data

stated in this manual.

2. Switch the main switch **A15** to the position “ON”.
3. Connect the TIG torch to the quick connector (-) **A1**.
4. Connect the earthing cable to the quick connector (+) **A3**.







5. By means of the switch **A5** switch to the position TIG .
6. Connect the gas hose to the gas cylinder connector on the gas bottle.
7. By means of the encoder **A14** set the welding current.

## TABLE OF CONSUMPTION DURING TIG WELDING



Wolfram electrode diameter [mm]	Argon flow [l/min]
	Steel / stainless steel
0,5	3 – 4
1,0	3 – 5
1,6	4 – 6
2,4	5 – 7
3,2	5 – 9

## 8. ROUTINE MAINTENANCE & INSPECTION

1. The only routine maintenance required for the PEGAS range of machines is a thorough cleaning and inspection, with the frequency depending on the usage and the operating environment.
2.  **WARNING**   
Disconnect the PEGAS from the mains supply voltage before disassembling.
3. Special maintenance is not necessary for the control unit parts in the Welder. If these parts are damaged for any reason, replacement is recommended.
4.  **CAUTION**   
Do not blow air into the welder during cleaning. Blowing air into the welder can cause metal particles to interfere with sensitive electronic components and cause damage to the welder.
5. To clean the welder, disconnect it from the mains supply voltage then open the enclosure and use a vacuum cleaner to remove any accumulated dirt and dust. The welder should also be wiped clean. If necessary, solvents that are recommended for cleaning electrical apparatus may be used.
6. Troubleshooting and repairing of PEGAS welding equipment should only be carried out only by suitably qualified or competent person.
7. A ‘competent person’ must be a person who has acquired through training, qualification or experience, or a combination of them, the knowledge and skills enabling that person to safely carry out a risk assessment and repairs to the electrical equipment in question.

8. The person carrying out the servicing needs and repairs must know what to look at, what to look for and what to do.

## 9. STATEMENT OF WARRANTY

1. In accordance with the warranty periods stated below, ALFA IN guarantees the proposed product to be free from defects in material or workmanship when operated in accordance with the written instructions as defined in this operating manual.
2. ALFA IN welding products are manufactured for use by commercial and industrial users and trained personnel with experience in the use and maintenance of electrical welding and cutting equipment.
3. ALFA IN will repair or replace, at its discretion, any warranted parts or components that fail due to defects in material or workmanship within the warranty period. The warranty period begins on the date of sale to the end user.
4. If warranty is being sought, please contact your ALFA IN product supplier for the warranty repair procedure.
5. ALFA IN warranty will not apply to:
  - a. Equipment that has been modified by any other party other than ALFA IN's own service personnel or with prior written consent obtained from ALFA IN Service Department.
  - b. Equipment that has been used beyond the specifications established in the operating manual.
    1. Installation not in accordance with the installation/operating manual.
  - c. Any product that has been subjected to abuse, misuse, negligence or accident.
  - d. Failure to clean and maintain (including lack of lubrication, maintenance and protection), the machine as set forth in the operating, installation or service manual.
6. Within this operating manual are details regarding the maintenance necessary to ensure trouble free operation.
7.  NOTE  Warranty repairs must be performed by either an ALFA IN Service Centre, an ALFA IN distributor or an Authorised Service Agent approved by the company ALFA IN.
8. As a warranty list serves proof of purchase (invoice) on which is the serial number of the machine, eventually a warranty list on the last page of this manual.

## 10. DISPOSAL



Only for EU countries. Do not dispose of electric tools together with household waste material.

 In accordance with European Council Directive 2002/96/EC on electrical and electronic equipment waste and its implementation in accordance with national law, electric tools that have reached the end of their service life

must be collected separately and returned to an environmentally compatible recycling facility.

## 11. WARRANTY LIST

As a warranty list serves proof of purchase (invoice) on which is the serial number of the machine, eventually a warranty list below, which is filled in by an authorized dealer.

Serial number:	
Day, month (written in words) and year of sale:	
Stamp and dealer signature:	